



Vítor Manuel Henriques Bernardo

Energy Efficient Multimedia Communications in IEEE 802.11 Networks

Tese de Doutoramento do Programa de Doutoramento em Ciências e Tecnologias da Informação, orientada pela Professora Doutora Marília Curado e pelo Professor Doutor Torsten Braun e apresentada ao Departamento de Engenharia Informática da Faculdade de Ciências e Tecnologia da Universidade de Coimbra

Fevereiro de 2015



UNIVERSIDADE DE COIMBRA

Energy Efficient Multimedia Communications in IEEE 802.11 Networks

*Eficiência Energética de Comunicações Multimédia
em Redes IEEE 802.11*

PhD Thesis submitted to the University of Coimbra
Tese de Doutoramento submetida à Universidade de Coimbra

Author:

Vítor Manuel Henriques Bernardo

Advisors:

Professor Marília Pascoal Curado

Professor Torsten Ingo Braun

*This research was partially supported by the Portuguese Foundation for Science and
Technology (FCT) through a doctoral grant (SFRH/BD/66181/2009).*



February 2015

With love to my grandfather, Fernando.
I will never forget you.

Acknowledgements

I would like to express my gratitude to everyone that helped make this Thesis come true.

A first and special word to my supervisor, Marilia Curado, for her ever so insightful comments and suggestions, for tolerating my delays, and for her unconditional support every step of the way. Your trust in my work was crucial. Thank you for the superb “trade-off” achieved during this long research journey, which has already started 9 years ago.

To my co-supervisor, Torsten Braun, thank you for pushing me out of my comfort zone, and allowing me to become better in a few new areas. Thank you for your kindly receptions and meetings during my stays in Bern. I really felt at home there.

During these years at LCT I had the pleasure to work alongside with fantastic people, always within a very welcoming atmosphere. To David Palma, Tiago Cruz and Vitor Fonseca, many thanks for the fruitful discussions and motivation. Bruno Sousa, thank you for introducing me to the OMNeT++ simulator and R framework, for always listening to me and for your constant availability. To João Almeida, many thanks for our “random” discussions and for letting me stay at your flat during the last few months.

Bruno Correia, thank you for accepting the challenge of implementing OPAMA in Android. Without you, I could not have had OPAMA working in a real mobile device. I was really delighted with your evolution and success.

Thank you also to Thomas Staub and Markus Anwander for sharing with me the basics and tricks regarding energy consumption measurements, but also for the great hospitality during my visits to Bern.

To the sysadmin guru, Ricardo Ruivo, many thanks for the coffees and for always supporting me, particularly with the management and configuration of the clusters machines. Your help was invaluable!

I would like to express my gratitude to the COST Action IC0906 (WiNeMO) for supporting my Short-Term Scientific Missions in Bern, Switzerland. Thank you also to COST Action IC0804 for the possibility to join summer schools and meetings.

Mauro Correia, thank you for allowing me to use your beautiful photograph on the cover of this Thesis.

To Crossfit Coimbra's community, a big thank you. You were crucial for my psychological balance during the last year - "*Mens sana in corpore sano*". To you, Inês Sineiro, Carolina Ribeiro, Rui Vitor Baltazar, Pedro Correia and Marta Mancelos, thanks for always being there for me. To Marta, many thanks also for the great "last minute" English revisions.

To my big friend, Marta Lopes, many thanks for the countless times that you listened to my complaints about the Thesis, even without knowing anything about this area. Thank you also to Nuno Gonçalves, Carina Padilha, Hugo Galvão, António Carvalho, Ricardo Martins, and to all the lifetime friends that I am missing here.

To Ana Filipa Silva, my eternal gratitude for the support and motivation during these last few years. To Ana's parents, José Manuel and Gina, many thanks also for everything.

Finally, to my parents, I will write in Portuguese. Por último, mas não menos importante, quero agradecer aos meus pais, José e Reinalda, pelo apoio incondicional nesta aventura e por todos os esforços que sempre fizeram para que este sonho fosse uma realidade.

Thank you to all who made this work possible!

Abstract

During the last decade wireless mobile communications have progressively become part of the people's daily lives, leading users to expect to be "always-best-connected" to the Internet, regardless of their location or time of day. This is indeed motivated by the fact that wireless access networks are increasingly ubiquitous, through different types of service providers, together with an outburst of thoroughly portable devices, namely laptops, tablets, mobile phones, among others. The "anytime and anywhere" connectivity criterion raises new challenges regarding the devices' battery lifetime management, as energy becomes the most noteworthy restriction of the end-users' satisfaction.

This wireless access context has also stimulated the development of novel multimedia applications with high network demands, although lacking in energy-aware design. Therefore, the relationship between energy consumption and the quality of the multimedia applications perceived by end-users should be carefully investigated. This dissertation addresses energy-efficient multimedia communications in the IEEE 802.11 standard, which is the most widely used wireless access technology. It advances the literature by proposing a unique empirical assessment methodology and new power-saving algorithms, always bearing in mind the end-users' feedback and evaluating quality perception.

The new EViTEQ framework proposed in this thesis, for measuring video transmission quality and energy consumption simultaneously, in an integrated way, reveals the importance of having an empirical and high-accuracy methodology to assess the trade-off between quality and energy consumption, raised by the new end-users' requirements. Extensive evaluations conducted with the EViTEQ framework revealed its flexibility and capability to accurately report both video transmission quality and energy consumption, as well as to be employed in rigorous investigations of network interface energy consumption patterns, regardless of the wireless access technology.

Following the need to enhance the trade-off between energy consumption and application quality, this thesis proposes the Optimized Power save Algorithm for continuous Media Applications (OPAMA). By using the end-users' feedback to establish a proper trade-off between energy consumption and application performance, OPAMA

aims at enhancing the energy efficiency of end-users' devices accessing the network through IEEE 802.11. OPAMA performance has been thoroughly analyzed within different scenarios and application types, including a simulation study and a real deployment in an Android testbed. When compared with the most popular standard power-saving mechanisms defined in the IEEE 802.11 standard, the obtained results revealed OPAMA's capability to enhance energy efficiency, while keeping end-users' Quality of Experience within the defined bounds. Furthermore, OPAMA was optimized to enable superior energy savings in multiple station environments, resulting in a new proposal called Enhanced Power Saving Mechanism for Multiple station Environments (OPAMA-EPS4ME).

The results of this thesis highlight the relevance of having a highly accurate methodology to assess energy consumption and application quality when aiming to optimize the trade-off between energy and quality. Additionally, the obtained results based both on simulation and testbed evaluations, show clear benefits from employing user-driven power-saving techniques, such as OPAMA, instead of IEEE 802.11 standard power-saving approaches.

Keywords:

IEEE 802.11, Energy Efficiency, Quality of Experience, Video Transmission, Android, Testbed

Resumo

Durante a última década as comunicações móveis sem-fios começaram, progressivamente, a fazer parte do quotidiano das pessoas, levando-as a criar expectativas de estarem sempre ligadas à Internet, independentemente da sua localização ou hora do dia. Esta expectativa é motivada pelo facto das redes de acesso sem-fios serem cada vez mais ubíquas, estando acessíveis através de diferentes meios e operadores, e também pela proliferação de vários dispositivos móveis como portáteis, *tablets*, telemóveis, entre outros. Este paradigma de estar ligado à rede a qualquer hora e em qualquer local” impõe novos desafios relacionados com a gestão da bateria dos dispositivos, levando o consumo energético a ser uma das mais assinaláveis limitações na qualidade percebida pelos utilizadores.

Este ambiente de acesso sem-fios estimulou o desenvolvimento de novas aplicações multimédia, caracterizadas por exigentes requisitos ao nível dos recursos de rede, mas sem qualquer tipo de optimização energética na sua concepção. Assim, a relação entre o consumo energético e a qualidade das aplicações multimédia deve ser investigada. Esta tese aborda a eficiência energética de comunicações multimédia em redes que seguem o padrão IEEE 802.11, o mais utilizado para o acesso sem-fios à rede. Ao propor uma nova metodologia de avaliação empírica e novos algoritmos energeticamente eficientes, tendo sempre em conta o *feedback* do utilizador final e avaliando a qualidade por este percebida, esta tese melhora os trabalhos já existentes.

A nova *framework* proposta nesta tese, designada por EViTEQ, permite avaliar de forma integrada a qualidade e consumo energético aquando da transmissão de vídeo. A sua utilização evidenciou a importância de uma metodologia que permita avaliar a relação custo/benefício entre o consumo energético e a qualidade percebida pelos utilizadores. Os vários testes efectuados revelaram a flexibilidade e capacidade da *framework* EViTEQ para ser utilizada de forma rigorosa e precisa, tanto na avaliação do custo/benefício entre energia e qualidade durante a transmissão de vídeo, como também em análises minuciosas do consumo energético de interfaces de rede sem-fios, independentemente da tecnologia em estudo.

Seguindo a necessidade de melhorar a relação custo/benefício entre consumo energético e qualidade, esta tese propõe um mecanismo para melhorar o desempenho

energético de aplicações multimédia com tráfego de rede contínuo, designado por OPAMA. Ao incluir o *feedback* do utilizador para melhorar a relação custo/benefício entre o consumo energético e o desempenho da aplicação, o OPAMA visa a melhoria da eficiência energética de dispositivos que acedem à rede através do padrão IEEE 802.11. O desempenho do OPAMA foi avaliado em vários cenários e com diferentes tipos de aplicações, incluindo um ambiente de simulação e um protótipo real com um dispositivo Android. Em comparação com os mecanismos de eficiência energética definidos no padrão IEEE 802.11, os resultados obtidos com o OPAMA mostraram a sua capacidade para aumentar a eficiência energética, preservando a Qualidade de Experiência dos utilizadores dentro dos níveis desejados. Adicionalmente, o OPAMA foi melhorado para garantir um melhor desempenho energético em cenários em que existem múltiplos dispositivos a aceder à rede em simultâneo, de onde resultou uma nova proposta de optimização específica para estes cenários, designada por OPAMA-EPS4ME.

Os resultados desta tese demonstram a importância de uma metodologia de alta-precisão para a avaliação integrada do consumo energético e qualidade de uma aplicação, tendo como objectivo a optimização da relação custo/benefício entre energia e qualidade. Para além disso, os resultados obtidos através de simulação e num protótipo real evidenciaram benefícios reais na utilização de técnicas de optimização energética que tenham em consideração o *feedback* do utilizador, tais como o OPAMA, em alternativa às abordagens definidas no padrão IEEE 802.11.

Palavras-chave:

IEEE 802.11, Eficiência Energética, Qualidade de Experiência, Transmissão de Vídeo, Android, Protótipo

Foreword

THE work presented in this thesis was performed at the Laboratory of Communication and Telematics (LCT) of the Centre for Informatics and Systems of the University of Coimbra (CISUC) within the context of the following projects:

Project iCIS – Intelligent Computing in the Internet of Services (iCIS), National project, funded by QREN, Programa Operacional Regional do Centro (CENTRO-07-ST24-FEDER-002003). In this project integrated the CISUC team and contributed to “Task 1.1 Future Networks”, by addressing challenges regarding energy efficiency in wireless broadband network technologies.

Project IC0804 – COST Action IC0804 - Energy Efficiency in Large Scale Distributed Systems. During the participation in this project contributed to the Focus Group on Energy Efficient Wireless Networking, which resulted in various joint publications with other institutions.

Project WiNEMO – COST Action IC0906 - Wireless Networking for Moving Objects (WiNEMO). During the participation in WiNeMO project was awarded with three Short-Term Scientific Mission (STSM) grants to perform part of the PhD work at University of Bern, Switzerland. The achieved results concerning this cooperation, between University of Coimbra and University of Bern, were presented in the project final audit.

Project EDPWiMAX – WiMAX Pilot for EDP Distribuição SA (EDPWiMAX). National project, funded by EDP Distribuição SA. In this project coordinated the implementation team and managed the network architecture definition and integration within the existing corporate network.

The conducted work resulted in the following publications:

- ▶ Vitor Bernardo, Vitor Fonseca, Marília Curado, Torsten Braun, “**Evaluation of Video Transmission Energy Consumption and Quality**”, *Wireless Personal Communications*, Special issue on “Researches and Challenges in green radio Communication: A Future World”, 2015 (in minor revisions)

- Torsten Braun, Philipp Hurni, Vitor Bernardo, Marilia Curado, “**Invited Abstract: Issues with State-based Energy Consumption Modelling**” , Proc. of the 2nd OMNeT++ Community Summit, IBM Research - Zurich, Switzerland, September 3-4, 2015
- Vitor Bernardo, Torsten Braun, Marilia Curado, Markus Fiedler, David Hock, Theus Hossmann, Karin Anna Hummel, Philipp Hurni, Selim Ickin, Almerima Jamakovic, Simin Nadjm-Tehrani, Tuan Ahn Trinh, Ekhiotz Jon Vergara, Florian Wamser, Thomas Zinner, “**Green Wireless Energy Efficiency in Wireless Networks**” in Large-Scale Distributed Systems and Energy Efficiency: A holistic view, Jean-Marc Pierson (Ed.), ISBN: 9781118864630, John Wiley & Sons, Inc., 2015 (to appear)
- Vitor Bernardo, Marilia Curado, Torsten Braun, “**An Overview of Energy Consumption in IEEE 802.11 Access Networks**” in Wireless Networking for Moving Objects, A. Kassler, I. Ganchev, M. Curado (Eds.), ISBN: 9783319108339, Lecture Notes in Computer Science (LNCS), Springer-Verlag, 2014
- Vitor Bernardo, Bruno Correia, Marilia Curado, Torsten Braun, “**Towards End-User Driven Power Saving Control in Android devices**”, The 14th International Conference on Next Generation Wired/Wireless Advanced Networking (NEW2AN 2014), 27-29 August 2014, St.Petersburg, Russia
- Vitor Bernardo, Marilia Curado, Torsten Braun, “**An IEEE 802.11 Energy Efficient Mechanism for Continuous Media Applications**”, Sustainable Computing: Informatics and Systems, Volume 4, Issue 2, June 2014, Pages 106-117, ISSN 2210-5379, <http://dx.doi.org/10.1016/j.suscom.2014.04.001>
- Bruno Correia, Vitor Bernardo, Marilia Curado, “**Towards Energy Efficient Multimedia Streaming in Mobile Devices**”, 18th Seminar of the RTCM (Mobile Communications Thematic Network), 21 February 2014, Coimbra, Portugal (Fast Abstract)
- Adriano Vinhas, Vitor Bernardo, Marilia Curado, Torsten Braun, “**Performance Analysis and Comparison between Legacy-PSM and U-APSD**”, 13th Portuguese Conference on Computer Networks (CRC 2013), 14-15 November 2013, Leiria, Portugal
- Vitor Bernardo, Marilia Curado, Torsten Braun, “**Enhancing IEEE 802.11 Energy Efficiency for Continuous Media Applications**”, EE-LSDS 2013, Energy

Efficiency in Large Scale Distributed Systems conference, 22-24 April 2013, Vienna, Austria (Best Paper Award)

- ▶ David Hock, Vitor Bernardo, Thomas Zinner, Florian Wamser, Karin A. Hummel, Marilia Curado, Rastin Pries, Torsten Braun, Phuoc Tran-Gia, "**Evaluating the Trade-off Between Energy Efficiency and QoE in Wireless Mesh Networks**", The Fourth International Conference on Communications and Electronics (ICCE'12) - Special Session on Energy-Efficient Networking, 1-3 August 2012, Royal city of Hue, Vietnam
- ▶ Vitor Bernardo, Marilia Curado, "**A Methodology for assessing Video transmission Energy Consumption and Quality**", International Workshop on Novel approaches to Energy Measurement and Evaluation in Wireless Networks (ICC'12 WS - NovaEnEv), 10 June 2012, Ottawa, Canada
- ▶ João Henriques, Vitor Bernardo, Paulo Simes, Marilia Curado, "**VoIP performance over Mobile WiMAX: An Urban Deployment Analysis**", 2nd Baltic Conference on Future Internet and Communications (BCFIC 2012), 25-27 April 2012, Vilnius, Lithuania
- ▶ Vitor Bernardo, Marilia Curado, Thomas Staub, Torsten Braun, "**Towards Energy Consumption Measurement in a Cloud Computing Wireless Testbed**", IEEE First International Symposium on Network Cloud Computing and Applications (IEEE NCCA 2011), pp.91-98, 21-23 November 2011, Toulouse, France
- ▶ Vitor Bernardo, Marilia Curado, Edmundo Monteiro, "**Advanced Cross-Layer Mobility Mechanisms in a Heterogeneous WLAN Scenario**" in Cross Layer Designs in WLAN Systems (Volume 2), pp.453-480, Nizar Zorba, Charalambos Skianis and Christos Verikoukis (Eds.), ISBN: 9781848768109, Troubador Publishing Ltd, Leicester, UK, November 2011

Contents

Contents	xvii
List of Figures	xxi
List of Tables	xxv
Abbreviations and Acronyms	xxvii
1 Introduction	1
1.1 Background and Motivation	1
1.2 Objectives and Contributions	3
1.3 Thesis Outline	6
2 Related Work	7
2.1 Basic Concepts	7
2.1.1 IEEE 802.11 Wireless Networks	8
2.1.2 Multimedia Video Applications and Quality Assessment	16
2.2 Video Transmission Energy Consumption and Quality Assessment in IEEE 802.11 Wireless Networks	27
2.3 IEEE 802.11 Energy Efficiency Improvements for Continuous Media Ap- plications	32
2.4 Summary	36
3 An Evaluation Framework to assess Video Transmission Energy Consump- tion and Quality	37
3.1 Introduction	38
3.2 EVITEQ: Evaluation framework to assess Video Transmission Energy consumption and Quality	38

CONTENTS

3.2.1	Core Components	39
3.2.2	Network Configuration	42
3.2.3	Measurement Parameters	43
3.3	Evaluation and Discussion	44
3.3.1	Assessment Procedure	44
3.3.2	Results	48
3.4	Investigating Energy Consumption in Wireless Access Networks using EViTEQ Framework	58
3.4.1	IEEE 802.11 Access Network Testbed and Scenarios	58
3.4.2	Energy Consumption of IEEE 802.11 States	59
3.4.3	Power Saving Effectiveness	61
3.4.4	Packet Size Impact	65
3.5	Summary	67
4	An IEEE 802.11 Energy Efficient Mechanism for Continuous Media Applica- tions	69
4.1	Introduction	69
4.2	Optimized Power Save Algorithm for Continuous Media Applications (OPAMA)	70
4.2.1	Motivation	70
4.2.2	Architecture	72
4.3	Performance Evaluation	77
4.3.1	Video Quality Assessment in OMNeT++	77
4.3.2	Simulation Scenario and Setup	80
4.3.3	Results	82
4.4	Summary	95
5	Power Saving Mechanisms in Multiple Station Environments	97
5.1	Introduction	97
5.2	Simulation Scenario and Setup	98
5.3	Power Saving Mechanisms Performance within Multiple Stations Sce- nario	99
5.3.1	Assessing the Impact of the Number of Stations on the Energy Saving Mechanisms	100
5.3.2	STA-MAD Impact on OPAMA Performance with Multiple Stations	110

5.3.3	Evaluating Energy Consumption and Video Quality with Multiple Stations	112
5.4	Enhancing Power Saving Mechanisms for Multiple Station Environments	119
5.4.1	Problem Statement	119
5.4.2	Enhanced Power Saving Mechanism for Multiple Station Environments (EPS4ME)	120
5.4.3	Results	122
5.5	Summary	127
6	OPAMA in Android devices	129
6.1	Introduction	129
6.2	Overview and Motivation	130
6.3	Android Testbed	131
6.4	Android Testbed Experimental Validation	133
6.4.1	Impact of Packet Size	134
6.4.2	Impact of Transmission Rate	136
6.5	EXPoSE: An Android Framework for Extending Power Saving Control to End-users	138
6.5.1	EXPoSE Design	139
6.5.2	Experimental Evaluation	140
6.6	OPAMA in Android	143
6.6.1	Implementation of OPAMA in an Android Testbed	143
6.6.2	Experimental Evaluation	147
6.7	Summary	150
7	Conclusion and Future Work	153
7.1	Thesis Summary	153
7.2	Revisiting the Contributions	154
7.3	Future Work	156
	References	157

CONTENTS

List of Figures

2.1	IEEE 802.11 A-MSDU aggregation scheme.	9
2.2	IEEE 802.11 MAC layer architecture	11
2.3	GOP structure for H.264/MPEG-4 AVC	18
2.4	PSNR error examples: both images have the same PSNR.	22
2.5	Accuracy comparison between SSIM and PSNR	24
2.6	VQM general model	25
2.7	Perceptual Evaluation of Video Quality metric overview	26
3.1	Architecture of the framework	39
3.2	Details of the energy measurement testbed	41
3.3	Selected video sequences: a) CrowdRun, b) InToTree, c) OldTownCross and d) ParkJoy	45
3.4	IEEE 802.11 testbed architecture	47
3.5	IEEE 802.11 native scenario: Structural Similarity (SSIM)	49
3.6	IEEE 802.11 native scenario: VQM	50
3.7	IEEE 802.11 native scenario: total energy consumption	52
3.8	Delay for extra delay Crowdrun video sequences	53
3.9	VQM for extra delay scenarios of Crowdrun sequences	53
3.10	VQM for extra delay scenarios of OldTownCross sequences	54
3.11	Packet loss for Crowdrun scenarios with configured packet loss	55
3.12	Frame loss for Crowdrun scenarios with configured packet loss	56
3.13	VQM for Crowdrun scenarios with configured packet loss	56
3.14	Total energy consumption for Crowdrun scenarios with configured packet loss	57
3.15	Simplified IEEE 802.11 states diagram	60
3.16	Average power in disconnected, idle and sleep states	60

LIST OF FIGURES

3.17	<i>NetworkCard-A 2.4GHz states transition with power saving disabled</i> . . .	62
3.18	<i>NetworkCard-A 2.4GHz states transition with power saving enabled</i> . . .	63
3.19	<i>NetworkCard-A 2.4GHz states transition with power saving enabled</i> . . .	64
3.20	Energy consumption with distinct packet sizes	66
3.21	Energy consumption with distinct packet sizes	67
4.1	Legacy PSM algorithm operation example.	71
4.2	OPAMA algorithm simplified operation example.	73
4.3	IEEE 802.11 MAC frame format (as in IEEE 802.11-2012 standard).	74
4.4	Video quality assessment methodology for OMNeT++ simulator.	78
4.5	No-PSM, Legacy-PSM and Legacy-PSM with Aggregation end-to-end delay.	83
4.6	No-PSM, Legacy-PSM and Legacy-PSM with Aggregation energy consumption.	84
4.7	End-to-end delay for OPAMA with Maximum Allowed Delay defined by the STA.	86
4.8	Energy savings with OPAMA, compared with Legacy-PSM and No-PSM scenarios.	87
4.9	SSIM for OPAMA with Maximum Allowed Delay defined by the STA.	87
4.10	Delay for distinct β configurations and Maximum Allowed Delay defined by the STA.	89
4.11	Energy consumption for distinct β configurations and Maximum Allowed Delay defined by the STA.	90
4.12	SSIM for distinct β configurations and Maximum Allowed Delay defined by the STA.	90
4.13	MTU impact on OPAMA delay.	92
4.14	MTU impact on OPAMA energy consumption.	93
4.15	MTU impact on end-users' perceived quality.	94
5.1	OMNeT++ simulation scenario with multiple stations.	99
5.2	Average energy consumption per STA with transmission rate of 50 packets/sec.	101
5.3	Average packet loss rate with transmission rate of 50 packets/sec.	102
5.4	Access Point queue statistics for all mechanisms with transmission rate of 50 packets/sec.	104
5.5	Delay CDF for all algorithms with transmission rate equal to 50 packets/sec.	105

5.6 Average energy consumption per STA with transmission rate of 100 packets/sec.	107
5.7 Average packet loss rate with transmission rate of 100 packets/sec. . . .	108
5.8 Maximum AP queue length with transmission rate of 100 packets/sec. .	109
5.9 Delay CDF for OPAMA with transmission rate of 100 packets/sec. . . .	109
5.10 Average energy consumption per STA of OPAMA with distinct STA-MADs (transmission rate of 50 packets/sec).	111
5.11 Delay of OPAMA with distinct STA-MADs (transmission rate equal to 50 packets/sec).	112
5.12 Average energy consumption per STA receiving Elephants Dreams video.	114
5.13 Average SSIM per STA receiving Elephants Dreams video.	115
5.14 Average packet loss rate per STA receiving Elephants Dreams video. . .	116
5.15 OPAMA delay CDF when receiving Elephants Dreams video.	116
5.16 Average energy consumption per STA of OPAMA with distinct STA-MADs receiving video.	117
5.17 Average SSIM per STA of OPAMA with distinct STA-MADs receiving video.	118
5.18 OPAMA operation with multiple stations.	119
5.19 OPAMA-EPS4ME operation with multiple stations.	121
5.20 OPAMA average energy consumption per STA with different CBR transmission rates and mechanisms.	123
5.21 OPAMA delay CDF with different CBR transmission rates and mechanisms	124
5.22 OPAMA average energy consumption per STA receiving video with the distinct mechanisms.	125
5.23 OPAMA delay CDF with different mechanisms receiving video.	125
5.24 OPAMA average SSIM per STA receiving video with the distinct mechanisms.	126
6.1 Architecture of IEEE 802.11 in Android. (Based on [Amuhong, 2015]) . .	131
6.2 IEEE 802.11 testbed architecture encompassing Android mobile device. .	132
6.3 Energy measurement testbed for mobile devices.	132
6.4 Total energy consumed by the IEEE 802.11 interface with different packet sizes.	134
6.5 One way delay for different packet sizes.	135

LIST OF FIGURES

6.6	Total energy consumed by the IEEE 802.11 interface with distinct transmission rates.	136
6.7	One way delay and loss rate for Legacy-PSM with distinct transmission rates.	138
6.8	EXPoSE framework architecture.	139
6.9	Energy savings and one way delay for EXPoSE pattern-based approach.	142
6.10	Energy savings and delay for EXPoSE maximum allowed delay scenarios.	144
6.11	Ethernet packet to control the IEEE 802.11 modes.	147
6.12	Energy saving of Simplified-OPAMA compared to the other algorithms under study.	148
6.13	One way delay for Simplified-OPAMA with distinct maximum allowed delays.	149

List of Tables

2.1	Quality level requirements for common video application	20
2.2	Mean Opinion Score quality score scale	21
2.3	Related work analysis summary	31
2.4	Related work summary	35
3.1	Parameters of compressed video sequences	46
3.2	Configured scenarios for the assessment	47
3.3	Quality ranking of sequences when employing SSIM and VQM metrics .	51
3.4	Experimental evaluation scenarios	59
3.5	Action sequence for testing states transitions	61
4.1	OMNeT++ simulation parameters.	81
4.2	Parameters of compressed video sequences	81
5.1	OMNeT++ simulation parameters.	100
5.2	Parameters of compressed video.	113
6.1	EXPoSE pattern-based configurations	141
6.2	One way delay for all standard mechanisms under study and for Simplified- OPAMA with MAD=100ms	149

LIST OF TABLES

Abbreviations and Acronyms

4G	Fourth Generation of mobile phone standards and technology
A-MSDU	Aggregated MAC Service Data Unit
A-MPDU	Aggregated MAC Protocol Data Unit
AC	Access Category
ACK	Acknowledgment
ANSI	American National Standards Institute
AP	Access Point
APSD	Automatic Power Save Delivery
AVC	Advanced Video Coding
CAP	Controlled Access Phase
CBR	Constant Bit Rate
CDF	Cumulative Distribution Function
CFP	Contention-Free Period
CMA	Continuous Media Application
CRF	Constant Rate Factor
CSMA/CA	Carrier Sense Multiple Access with Collision Avoidance
CTS	Clear-To-Send
CW	Contention Window
DCF	Distributed Channel Function
DIFS	DCF Interframe Space
DSSS	Direct Sequence Spread Spectrum
EDCA	Enhanced Distributed Channel Access

0. Abbreviations and Acronyms

EDGE	Enhanced Data rates for Global Evolution
EPS4ME	Enhanced Power Saving Mechanism for Multiple station Environments
ERP	Extended Rate PHY
EVITEQ	Evaluation Framework to assess Video Transmission Energy Consumption and Quality
EXPOSE	Android framework for Extending Power Saving control to End-users
FHSS	Frequency Hopping Spread Spectrum
FPS	Frames Per Second
GOP	Group of Pictures
H.264	MPEG-4, Advanced Video Coding (Part 10)
HC	Hybrid Coordinator
HCCA	Hybrid Coordination Function Controlled Channel Access
HCF	Hybrid Coordination Function
HDTV	High-Definition Television
HSPA	High Speed Packet Access
HT	High Throughput
HVS	Human Visual System
IETF	Internet Engineering Task Force
IaaS	Infrastructure as a Service
IP	Internet Protocol
IPPM	IP Performance Metrics
IPTV	Internet Protocol Television
IR	Infrared
LLC	Logical Link Control
LTE	Long Term Evolution
MAC	Medium Access Control
MAD	Maximum Allowed Delay
MIMO	Multiple-Input and Multiple-Output
MLME	Medium Access Control (MAC) Sublayer Management Entity
MOS	Mean Opinion Score

MPDU	MAC Protocol Data Unit
MPEG	Moving Pictures Experts Group
MSDU	MAC Service Data Unit
MSE	Mean Squared Error
MTU	Maximum Transmission Unit
MU-MIMO	Multi-user MIMO
NGN	Next Generation Network
NTIA	National Telecommunications and Information Administration
OFDM	Orthogonal Frequency Division Multiplexing
OPAMA	Optimized Power save Algorithm for continuous Media Applications
OSI	Open Systems Interconnection
PaaS	Platform as a Service
PCF	Point Coordination Function
PEVQ	Perceptual Evaluation of Video Quality
PHY	Physical Layer
PLCP	Physical Layer Convergence Protocol
PMD	Physical Medium Dependent
PS-Poll	Power Save Poll frame
PSM	Power Save Mode
PSMP	Power Save Multi-Poll
PSNR	Peak Signal to Noise Ratio
PSQA	Pseudo-Subjective Quality Assessment
PSTN	Public Switched Telephone Network
PTP	Precision Time Protocol
PVB	Partial Virtual Bitmap
QAM	Quadratic Amplitude Modulation
QoE	Quality of Experience
QoS	Quality of Service
RTP	Real-Time Protocol

0. Abbreviations and Acronyms

RTS	Request-To-Send
S-APSD	Scheduled Automatic Power Save Delivery
SaaS	Software as a Service
SIFS	Short Inter-Frame Space
SM	Spatial Multiplexing
SP	Service Period
SSIM	Structural Similarity
STA	Station
STA-MAD	Station Maximum Allowed Delay
TCP	Transmission Control Protocol
TID	Traffic Identifier
TIM	Traffic Indication Map
TXOP	Transmit Opportunity
U-APSD	Unscheduled Automatic Power Save Delivery
UDP	User Datagram Protocol
VBR	Variable Bit Rate
VCEG	Video Coding Experts Group
VoD	Video on Demand
VQEG	Video Quality Experts Group
VQM	Video Quality Metric
WLAN	Wireless Local Area Network

— We should be taught not to wait for inspiration to start a thing. Action always generates inspiration. Inspiration seldom generates action.

Frank Tibolt

1

Introduction

THIS thesis is focused on energy efficient multimedia communications in IEEE 802.11 networks. This initial chapter presents the motivation that lead to the research performed, followed by a description of its main goals and contributions. Afterwards, the document's structure is outlined.

1.1 Background and Motivation

Next Generation Network [Lee and Knight, 2005] is the common term to describe a packet-based broadband network, designed to transparently support all services and information exchange under all available networks. Since the network communication is based on packet encapsulation, and since the Internet Protocol (IP) is widely deployed, the term "all-IP" network is commonly associated with the development of a Next Generation Network (NGN).

This emerging era of access networks that is being spearheaded by Fourth Generation of mobile phone standards and technology (4G) systems has as main objective the creation of high speed wireless technologies based on an "all-IP" approach, which will grant better performance and optimize the communication with IP-based core

1. Introduction

systems, such as the Internet. The optimization of 4G systems (e.g., Long Term Evolution (LTE) [Sesia et al., 2009]), together with the widely used Wireless Local Area Network (WLAN) technology IEEE 802.11 [IEEE, 2012], will provide connectivity to global wireless communication systems that have different capabilities and costs.

Despite the fast evolution of access technology, the cloud-computing paradigm has emerged [Sanaei et al., 2014] as more end-user oriented than typical access networks, and whose main goal is to have all services accessible “anytime and anywhere”. There is not a clear agreement in the community about cloud computing service types, since they are extremely reliant on which users or brokers are accessing them. Depending on the type of usage / capacity provided, the cloud scenarios are commonly classified into Infrastructure as a Service (IaaS), Platform as a Service (PaaS) and Software as a Service (SaaS) [Wu et al., 2014].

Concerning SaaS, many multimedia-based applications have arisen during recent years, with more and more people using them. Due to the characteristics of these types of applications, particularly video streaming, there will be greater demands from users regarding the access technology. Therefore, it is important for both operators and end-users to measure the quality of the applications, in order to assess the capabilities of a certain network to provide the needed quality. Additionally, aiming at fulfilling the end-users’ needs regarding the service’s availability “anytime and anywhere”, there was also a fast-growing demand concerning the performance of portable devices, namely processing capabilities, screen quality, and battery life. Unlike the development of other components, where Moore’s Law is still valid, this is not the case when it comes to the battery. In fact, Fred Schlachter shows that there is no Moore’s Law for batteries [Schlachter, 2013].

The application’s quality assessment is historically associated with the evaluation of some parameters at the network layer [Orosz et al., 2014]. Unfortunately, the common metrics associated with Quality of Service (QoS), namely the available bandwidth, delay, or packet loss ratio, have as their main drawback the inability to represent the real quality perceived by the end-users at the application level. To overcome this limitation, a novel concept has been developed, the Quality of Experience (QoE) [Wechsung and De Moor, 2014]. By employing QoE-aware techniques, it is possible to understand the end-user’s real perception of quality, providing complementary information to the QoS parameters. Nonetheless, another QoE-related parameter that has to be contemplated is the device’s power consumption rate, or battery lifetime. Undoubtedly, energy efficiency becomes itself an important end-user QoE parameter, because end-users always aim at maximizing the device’s battery life.

Although several mobile devices have Internet access through mobile operator networks, performance limitations when transmitting highly demanding multimedia applications enabled novel and hybrid communication paradigms (e.g., offloading), where IEEE 802.11 plays an important role [Picard and Lafond, 2014]. With regard to the relationship between wireless access networks and energy consumption, although numerous efforts have been done to create low-power radio technologies (e.g., IEEE 802.15.4 and ZigBee), IEEE 802.11 stands out within the context of wireless access communications. With the proliferation of IEEE 802.11-ready devices, ranging from sensors to mobile phones or laptops, this technology also emerges as a strong candidate to support a substantial part of the upcoming future Internet.

Driven by the need to assess the trade-off between multimedia application quality and energy consumption within the NGN context, a framework able to combine the study of the end-user's perceived QoE and energy consumption, regardless of the employed wireless access technology, should be defined. Former works showed that correct energy management can be critical for the acceptance of new services, while there are clear deficiencies concerning energy-aware optimization, taking into account the end-users' requirements. Therefore, an end-user-driven energy efficient mechanism to support multimedia applications, with a desired QoE level, shall be proposed. In this context, due to the proliferation of the aforementioned mobile devices, the real impact of the proposed solution in real systems shall be investigated.

1.2 Objectives and Contributions

The main goals of this work are to define a methodology that allows the combined assessment of multimedia application quality and energy consumption in an integrated way, and to propose a mechanism to optimize the IEEE 802.11 network interface's energy consumption when receiving video, driven by the end-users' requirements. The specific objectives are as follows:

- O.1** Define a framework to enable a high-precision, empirical, and integrated study concerning video transmission quality and energy consumption, regardless of the wireless access technology in use;
- O.2** Propose a mechanism that can improve the IEEE 802.11's energy efficiency according to the end-users' needs, when receiving video;
- O.3** Study the performance of the most popular power-saving mechanisms de-

1. Introduction

defined in the IEEE 802.11 standard. The assessment must include distinct application traffic patterns and environments where multiple stations compete for access network resources.

The main contributions of this thesis are summarized as follows.

Contribution 1 - EViTEQ framework

The conceptual definition and implementation of an Evaluation Framework to assess Video Transmission Energy Consumption and Quality (EViTEQ) represents a significant contribution of this thesis, as it enables an integrated solution to measure, in a combined way, the video streaming quality and energy consumption. The related work analysis revealed a lack of an integrated framework with such capabilities, leading to the design of the EViTEQ framework, which stands as a valid solution in the assessment of distinct network scenarios, regardless of the wireless access technology. Moreover, even though it is designed to accomplish the combined video quality / energy evaluation, the proposed framework can also be used to perform highly accurate energy efficiency studies using other applications. This contribution meets goal **O.1**.

Contribution 2 - Empirical assessment of video quality and energy consumption

This contribution seeks to overcome an existing literature gap regarding the assessment of video quality and energy consumption in real testbeds. Besides validating the EViTEQ framework in distinct scenarios, the outlined empirical assessment, conducted in an IEEE 802.11 testbed, allows the study of the impact of different video characteristics and network conditions on the end-user's perceived quality and energy consumption.

Contribution 3 - Proposal of a power saving algorithm for continuous media applications

The proposal, modeling, and assessment of the Optimized Power save Algorithm for continuous Media Applications (OPAMA) is a core contribution of this work, and it meets objective **O.2**. The OPAMA algorithm was designed to improve IEEE 802.11 energy efficiency, while taking into account the end-users' needs. It has been modeled and compared against the most relevant IEEE 802.11 standard algorithm in the

OMNeT++ simulator [Varga and Hornig, 2008]. This thesis also contributes to the enhancement of the OMNeT++ open-source simulator, as the two most relevant power-saving strategies defined in the IEEE 802.11 standard were modeled. Moreover, a hybrid approach that uses the OMNeT++ simulator and a real machine to evaluate video quality was also advanced.

Contribution 4 - Performance assessment of IEEE 802.11 power savings mechanisms

This contribution meets goal **O.3**, as a detailed performance assessment of the most relevant power-saving strategies defined in the IEEE 802.11 standard was performed in the OMNeT++ simulator. This evaluation includes the usage of both synthetic and video Variable Bit Rate (VBR) traffic sources, while also considering a distinct number of stations present in the network.

Contribution 5 - Proposal of an enhanced power saving mechanism for multiple stations environment

Driven by a limitation identified when the power-saving mechanisms are used in the presence of multiple stations, an enhanced power-saving mechanism for multiple station environments (OPAMA-ESP4ME) was proposed. Apart from the conceptual definition and modeling of OPAMA-ESP4ME, this contribution also encompasses its performance assessment and analysis.

Contribution 6 - Energy-aware Android prototype design and implementation

A final contribution of this thesis consisted in the definition of an Android energy-aware testbed, allowing the proposed protocols to be assessed in a real world environment. Various limitations were identified concerning the power-saving management of the IEEE 802.11 network interface in Android devices. To address such limitations, a framework (EXPoSE) to allow power-saving control to be performed at the application level has been proposed. Furthermore, a simplified version of the OPAMA mechanism was implemented, and its performance has been compared with state-of-the-art power-saving algorithms, available in the most recent release of the Android operating system. Some of the implementation and testing tasks were performed together with Master student Bruno Correia.

1.3 Thesis Outline

This section briefly introduces the outline of this thesis.

Chapter 2 introduces the IEEE 802.11 technology and standard power-saving mechanisms. The requirements to accurately assess video transmission quality and energy consumption are also identified in this chapter, followed by the discussion of the most relevant works addressing the subject. The IEEE 802.11 energy efficiency improvements for multimedia continuous media applications in the literature are discussed in this chapter as well.

Chapter 3 proposes EViTEQ, an Evaluation Framework to assess Video Transmission Energy Consumption and Quality, aiming at fulfilling the gap concerning existing techniques to assess video transmission quality and energy consumption, identified in Chapter 2. An investigation regarding energy consumption in IEEE 802.11 networks using the EViTEQ framework is also performed, depicting the framework versatility and accuracy to study different access scenarios.

Chapter 4 introduces the Optimized Power save Algorithm for continuous Media Applications (OPAMA), aiming at improving the IEEE 802.11 energy efficiency for Continuous Media Applications (CMAs), while keeping the end-user QoE within the desired level. The simulation results obtained in OMNeT++, together with the developed hybrid video quality assessment methodology, show OPAMA's capabilities to guarantee the expected trade-off between energy consumption and attained quality.

Chapter 5 discusses the performance of the standard power-saving mechanisms and OPAMA, when used within a multiple station environment. Besides this detailed performance assessment, an Enhanced Power-Saving Mechanism for Multiple station Environments (EPS4ME) approach has been proposed, aiming at addressing the main limitations identified when multiple stations are competing for the resources.

Chapter 6 investigates the energy efficiency of the power-saving mechanism available in Android devices when compared with the end-user-driven approach proposed in this thesis. A simplified version of OPAMA was implemented and a framework to enable power-saving control at the application level was proposed. The assessment was conducted in a real testbed, encompassing an Android mobile device and a high-accuracy energy measurement facility.

Finally, **Chapter 7** presents the final remarks of this thesis and outlines future research work.

— *Know how to solve every problem that has ever been solved.*

Richard Feynman

2

Related Work

THIS chapter introduces the IEEE 802.11 standard and discusses the most relevant related work on energy efficient multimedia communication. Section 2.1 presents the IEEE 802.11 standard and the basic concepts behind video streaming transmission and quality assessment. Afterwards, in Section 2.2, the relevant literature concerning video transmission energy consumption and quality in IEEE 802.11 networks is analyzed, followed by the discussion and analysis of IEEE 802.11 energy efficiency mechanisms to support Continuous Media Applications in Section 2.3. Finally, Section 2.4 provides a summary of the chapter.

2.1 Basic Concepts

This section introduces the basic concepts behind the IEEE 802.11 standard in Subsection 2.1.1. Subsection 2.1.2 gives an overview of video applications and presents the most used metrics and standards to perform quality evaluation.

2. Related Work

2.1.1 IEEE 802.11 Wireless Networks

This subsection introduces the IEEE 802.11 standard main features and presents the power-saving mechanisms defined in the various amendments.

2.1.1.1 Overview

IEEE 802.11 [IEEE, 2012] is the most well deployed standard to support Wireless Local Area Networks (WLANs) links. It is used in different places, such as homes, small offices, and public areas. Public market statistics show that IEEE 802.11 ready devices surpass 1.5 billions in 2012, with estimations pointing out to around 5 billions in 2017 [Statista, 2015]. The IEEE 802 LAN/MAN Standards Committee (LMSC) maintains the WLAN Working Group, which is responsible for the IEEE 802.11 standards. Moreover, the “Wi-Fi Alliance” nonprofit association is responsible for the certification of the IEEE 802.11 ready equipment [Alliance, 2015].

The IEEE 802.11-2007 standard [IEEE, 2007], which merges amendments IEEE 802.11a, b, d, e, g, h, i, and j, enables the wireless access in the frequencies of 2.4 GHz and 5.0 GHz (IEEE 802.11a) with a peak data rate of 54 Mb/s. One of the most relevant amendments present in this release is IEEE 802.11e [IEEE, 2005]. IEEE 802.11e defines the first Quality of Service provisioning mechanisms of the standard. Later, IEEE 802.11n [IEEE, 2009] has specified a theoretical throughput up to 600 Mb/s, working at 2.4 GHz or 5.0 GHz frequencies and using 40 MHz channels. This revision improves the Physical Layer (PHY) by using Multiple-Input and Multiple-Output (MIMO) techniques with Orthogonal Frequency Division Multiplexing (OFDM). Apart from the PHY layer optimization, it also introduces new Medium Access Control (MAC) layer frame aggregation, aiming to improve the network throughput and efficiency. The proposed MAC enhancements consist of two distinct approaches to perform MAC frame aggregation, named Aggregated MAC Service Data Unit (A-MSDU) and Aggregated MAC Protocol Data Unit (A-MPDU).

The A-MSDU scheme, depicted in Figure 2.1, consists in the concatenation of multiple MAC Service Data Units (MSDUs) as a single MAC Protocol Data Unit (MPDU). By allowing multiple MSDUs to be transmitted together, this technique enhances the MAC layer efficiency, as the transmission overhead will be reduced (e.g., PHY preamble). The frames to be aggregated are received through the upper-layers and packed as a single MPDU, but the IEEE 802.11n standard does not define rules to perform it. Various works in the literature address this issue by using a threshold-based solution, which can take into account the total frame size, delay or combinations thereof

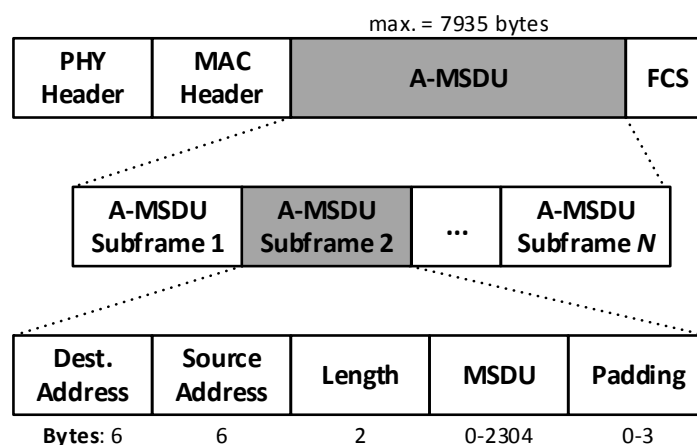

Figure 2.1: IEEE 802.11 A-MSDU aggregation scheme.

[Skordoulis et al., 2008]. A-MSDU maximum frame size is limited by the IEEE 802.11 standard Maximum Transmission Unit (MTU). Moreover, all the frames must have the same source and destination, but also the same Traffic Identifier (TID) (traffic flow characterization field in IEEE 802.11 standard). Devices compliant with IEEE 802.11n standard must support A-MSDU at the receiver.

The main difference between A-MSDU and A-MPDU schemes is that with A-MPDU the data aggregation is performed after MAC layer header encapsulation. Therefore, A-MPDU allows traffic with distinct TIDs to be aggregated, however the destination of each single frame must be the same. Further improvements to aggregation schemes have been addressed in the literature, with schemes based on the two-level aggregation concept being the most popular ones [Noma et al., 2015].

More recently, an extension to IEEE 802.11n, IEEE 802.11ac [IEEE, 2013][Verma et al., 2013], aiming at supporting gigabit Ethernet access speeds, was proposed. IEEE 802.11ac main improvements include the introduction of Multi-user MIMO (MU-MIMO) techniques in the downlink, extended channel binding with a mandatory 80Mhz channel for Stations (STAs) and a new 256 Quadratic Amplitude Modulation (QAM) modulation scheme.

2.1.1.2 Physical Layer Overview

IEEE 802.11 standard physical layer is composed by two distinct sub-layers, namely the Physical Layer Convergence Protocol (PLCP) and the Physical Medium Dependent (PMD). PLCP handles the communication between Physical and MAC layers. This sub-layer introduces the PHY layer header and preamble in the frames and per-

2. Related Work

forms all management operations. The PMD is responsible for transmitting the information received to/from the PLCP to the air, translating the digital signals to analog and vice versa.

The first IEEE 802.11 standard, from 1997, defined three distinct physical layers, namely Infrared (IR), Frequency Hopping Spread Spectrum (FHSS), and Direct Sequence Spread Spectrum (DSSS). Later, the OFDM specification was introduced in amendment IEEE 802.11a. Various PHY layer improvements were also addressed by IEEE 802.11g and 802.11n, leading to the specification of two new proposals, the Extended Rate PHY (ERP) and the High Throughput (HT) PHY, respectively.

The IEEE 802.11ac amendment is mainly focused on PHY layer and provides several enhancements aiming at achieving higher throughput. Further discussion concerning the latest IEEE 802.11 PHY improvements was performed by Verma et al. [Verma et al., 2013].

Since this thesis does not target the PHY layer, details concerning the various specifications will not be discussed, but they can be found in IEEE 802.11ac standard [IEEE, 2013].

2.1.1.3 Medium Access Control Layer Overview

IEEE 802.11 MAC layer is a sub-layer of the Open Systems Interconnection (OSI) model's Data Link Layer, as depicted in Figure 2.2. The interface between the MAC sub-layer and the upper layers (i.e., network layer) is performed by the Logical Link Control (LLC).

MAC layer main functions are to enable the reliable data delivery, ensure a fair access to the medium, and enable data security. Various MAC layer functions have been defined in the IEEE 802.11 standard, namely Distributed Channel Function (DCF), Point Coordination Function (PCF), Enhanced Distributed Channel Access (EDCA), and Hybrid Coordination Function Controlled Channel Access (HCCA). These functions are briefly described next.

Distributed Coordination Function (DCF)

The Distributed Channel Function is a mandatory MAC layer access function defined in the IEEE 802.11 standard, which is based on the Carrier Sense Multiple Access with Collision Avoidance (CSMA/CA) and uses a backoff algorithm. The main idea behind DCF is that a STA, with a frame to be transmitted, should listen the medium

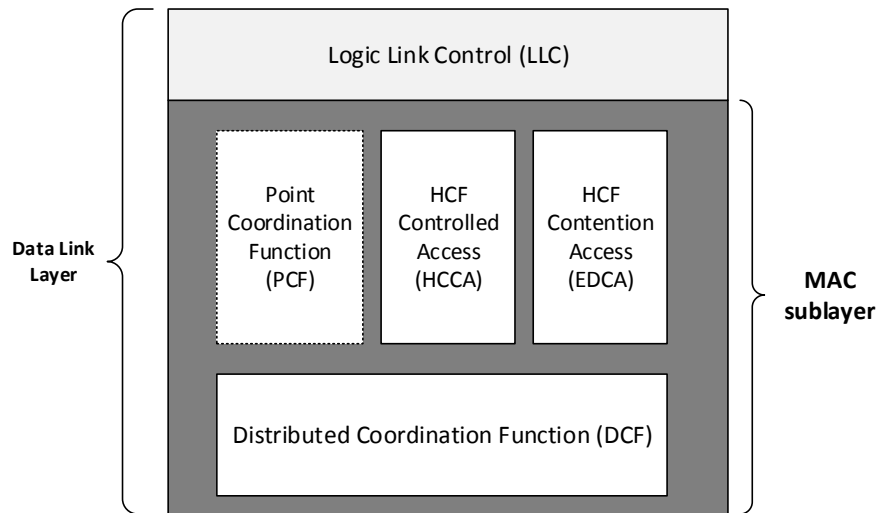

Figure 2.2: IEEE 802.11 MAC layer architecture
(Based on [IEEE, 2012])

and only transmit if the channel is idle.

Whenever the channel is idle, the station should defer the access for an extra period, named DCF Interframe Space (DIFS). If the channel was initially busy and becomes idle, a random backoff before starting the transmission must be introduced. The backoff time is selected in the range of $[0, W-1]$, where W is the actual backoff window size (initial W value is equal to the minimum Contention Window (CW), CW_{min}). For each failed transmission, W is doubled until the maximum backoff CW , CW_{max} , is reached. If the medium is idle, the backoff time is decreased, and the station will be allowed to start the transmission as soon as the counter reaches zero.

After a successful transmission, the receiving station must send an Acknowledgment (ACK) back. The acknowledgment transmission is always preceded by a Short Inter-Frame Space (SIFS) period. If the sender does not receive the ACK within the expected time, a retransmission is scheduled.

DCF also defines a mechanism to reduce the collisions in hidden node scenarios. The hidden node scenario occurs if a station, STA-A, is within the transmission range of two other stations, STA-B and STA-C, and those last stations can not hear each other. As a result, STA-B and STA-C might send data to STA-A at the same time. This issue is addressed by an optional DCF mechanism named Request-To-Send (RTS) / Clear-To-Send (CTS) handshake. The basic idea of RTS/CTS handshake is to perform the channel “reservation” before the transmission. This is achieved by always sending a RTS frame before data transmission, that should be acknowledged with a CTS frame

2. Related Work

to trigger the data transmission start. Nevertheless, collisions can still occur in the RTS frame.

Point Coordination Function (PCF)

The IEEE 802.11 standard also defines an optional access method using a Point Coordination Function. PCF allows the Access Point (AP) to act as the network point coordinator and, consequentially, to centralize the channel access management.

In PCF, a station can only transmit to the medium when polled by the AP (i.e., point coordinator). When polled, if the station has pending packets to be transmitted it should send them immediately. Otherwise, when there are no pending data to be transmitted, the station should acknowledge the AP using a Null-Data + CF-ACK frame.

In fact, PCF is not widely used in real systems and only few commercial devices implement it [Tsao and Huang, 2011]. The main reason is that this access method is optional in the IEEE 802.11 standard, and it is also not included in the “Wi-Fi Alliance” certification.

Hybrid Coordination Function (HCF)

A new coordination function, named Hybrid Coordination Function, targeting the support of QoS in the IEEE 802.11 standard, has been proposed in the IEEE 802.11e amendment. Hybrid Coordination Function (HCF) enhances the Distributed Channel Function and the Point Coordination Function, through two distinct access methods: Enhanced Distributed Channel Access (EDCA) and Hybrid Coordination Function Controlled Channel Access (HCCA).

EDCA enhances the Distributed Channel Function scheme by providing differentiated channel access to the frames based on the user priority defined in the higher layers. By providing different Contention-Free Period (CFP) to the channel, named Transmit Opportunity (TXOP), EDCA ensures the application prioritization. During the TXOP a station can transmit as many data as possible. Four distinct Access Categories (ACs) have been defined, namely *AC_VO*, *AC_VI*, *AC_BE* and *AC_BK*, which target voice, video, best effort and background applications, respectively. Apart from specific TXOP, each access category has also different configuration for maximum / minimum contention window and arbitration inter-frame spacing.

HCCA works in a way similar to PCF, using a Hybrid Coordinator (HC) (e.g., Access Point) to perform the central management and allocation of the resources. Nevertheless, unlike Point Coordination Function, the Hybrid Coordination Function Controlled Channel Access enables a new type of Contention-Free Period, the Controlled Access Phase (CAP), which allows a Contention-Free Period to be started anytime during a contention period and creates transmission opportunities for the stations. In this QoS parameterization approach a virtual connection, named traffic stream, is firstly established between the transmitter and the receiver. This virtual flow includes the QoS requirements (e.g., throughput) of the desired connection, being exchanged between the requesting clients and the supporting station.

Unlike EDCA, HCCA support is not mandatory for an access point to be compliant with IEEE 802.11e standard or to go through the “Wi-Fi Alliance” market certification. Therefore, as PCF, HCCA is also seldom used in real deployments.

2.1.1.4 Power Saving in IEEE 802.11

The IEEE 802.11 standard [IEEE, 2012] defines a power management mode that allows the station to turn off both transmitter and receiver capabilities in order to save energy. The power management operations are distinct in infrastructure and ad-hoc modes. This section will discuss power management operations in the infrastructure mode, since it is the most widely used. The IEEE 802.11 power saving procedure was originally defined by IEEE 802.11-1997 and it is generically named Power Save Mode (PSM) (also known as Legacy-PSM). Later, the IEEE 802.11e [IEEE, 2005] introduced, together with many QoS related enhancements, two additional power save mechanisms, the unscheduled and the scheduled Automatic Power Save Delivery (APSD). More recently, IEEE 802.11n [IEEE, 2009] also announced two contributions to the power save schemes, namely the Spatial Multiplexing (SM) Power Save and the Power Save Multi-Poll (PSMP) techniques. A brief description of these techniques will be performed in the next subsections.

Power Save Mode (PSM)

In the Power Save Mode, the station is able to stay disconnected from the network for a certain period. The station must inform the access point about the current power management mode by defining the corresponding power management bits in the control frames. When the power saving is enabled for a certain station, the access point

2. Related Work

buffers all the packets to that station. If the access point has packets buffered to a certain station, it will send this information via the Traffic Indication Map (TIM) within the *Beacon Frames*. In PSM, a station must wake-up regularly to receive the TIM information present in *Beacon Frames*. Listening must be performed every N beacons, where $N \geq 1$. This period is named Listen Interval. By performing this action a station, which does not have any data buffered on the access point, will be required to awake up recurrently, resulting in unnecessary energy consumption.

To receive the buffered frames in the access point, the station must send back a Power Save Poll frame (PS-Poll) frame. When receiving a *PS-Poll* frame from a station, the access point can acknowledge it first or send the queued data directly. In the first time, the access point sends only one frame to the station and sets the *MoreData* bit in the frame. When a station receives a frame with the *MoreData* information bit enabled, it must send back a *PS-Poll* to the access point.

The PSM usage allows the access point to buffer the packets to a certain station when in sleep mode, however it does not have any mechanism to buffer packets from the station to the access point. As a result, when an application wants to send a packet to the core network, it will not be queued and the sleep mode will be immediately interrupted.

Automatic Power Save Delivery (APSD)

IEEE 802.11e introduces the QoS paradigm in the standard by defining two distinct QoS prioritization schemes, a distributed one defined by the Enhanced Distributed Channel Access channel access mode, and a centralized one defined by the Hybrid Coordination Function Controlled Channel Access. Aligned with the QoS prioritization modes, a novel power save mode entitled APSD was specified. APSD introduces a concept named Service Period (SP), which is a time reserved for a certain station to exchange data with the access point. With the employment of the SP concept, the stations do not need to contend for the channel, which results in less energy consumption.

APSD can work in two distinct modes: Scheduled Automatic Power Save Delivery (S-APSD) and Unscheduled Automatic Power Save Delivery (U-APSD). The S-APSD is a centralized approach and can use both EDCA and HCCA as access policy, while U-APSD is a distributed method, which uses EDCA. The key point in the U-APSD design is the usage of the station uplink frames as triggers to deliver the buffered data in the access point while the station is sleeping. By employing such de-

sign, the station has full control on the awake moment, as this instant does not need to be previously negotiated with the access point. Additionally, the station does not need to listen regularly for the access point beacons. The U-APSD usage is specially indicated for bidirectional scenarios, but alternative scheduling techniques might be used to trigger the access point buffered data. The access point can be triggered by receiving either a QoS Data frame or a QoS null frame (equivalent to the *PS-Poll* frame in the Legacy-PSM). For instance, a station without uplink traffic to be transmitted to the network can use the QoS null frame to enquire the access point about remaining buffered frames. Moreover, each access category defined in EDCA can be configured individually regarding buffered data triggering, which enables additional control concerning the station energy management capabilities.

In the S-APSD centralized scheme the access point schedules the instants when each station using S-APSD should awake-up to receive data. Both HCCA and EDCA can be used as channel access methods, nonetheless the implementation of the first is not mandatory in the standard. Additional information regarding APSD can be found in the literature [Prez-Costa et al., 2007].

Spatial Multiplexing (SM) Power Save

Spatial Multiplexing (SM) Power Save was introduced in IEEE 802.11n considering the energy demands usually associated with MIMO techniques, as the operation with multiple antennas in multiple channel requires extra power. The SM Power Save allows the station to disconnect all but one of its radio frequency chains. The SM Power Save mode can operate into two distinct modes: static and dynamic.

When operating in the static mode, the IEEE 802.11 ready station must disconnect all but one radio frequency chain, being comparable to a legacy IEEE 802.11g station. The access point is notified that the station will be operating in the static SM power save mode, requiring the access point to send only a single spatial stream to the client, until the client informs about the availability of additional radio frequency chains. With the dynamic mode, the station also keeps only one active radio frequency chain, but in this mode the station can promptly activate additional radio frequency chains when receiving a frame.

2. Related Work

Power Save Multi-Poll (PSMP)

IEEE 802.11n also introduced a power save mechanism entitled Power Save Multi-Poll. The PSMP aims to solve the issues related with channel contention needed in the Automatic Power Save Delivery method described above. In APSD, the stations are required to send a *PS-Poll* frame (i.e., QoS null frame) to the access point in order to collect its buffered packets. The contention generated by these actions might be critical for network performance if many station are requesting the buffered packets, resulting in lower channel efficiency.

In PSMP, the access point can schedule data transmission according to the application QoS constraints, namely delay and bandwidth. The AP will specify the scheduling for a certain station downlink and uplink traffic in the beacon frames, allowing the station to awake up only when it is able to transmit data. Although the PSMP mechanism can reduce contention of the polling mechanism and improve the channel efficiency, it is not as energy efficient as U-APSD, since the station must awake up periodically to receive the schedule information contained in the beacons sent by the access point [CISCO, 2011].

2.1.2 Multimedia Video Applications and Quality Assessment

This subsection presents the main characteristics of most popular video applications in today's networks, followed by the discussion regarding the most used metrics and standards to assess video quality.

2.1.2.1 Overview

Nowadays many computer applications, specially multimedia applications, are increasingly taking a large importance in society which is becoming a true technological society. With the widespread deployment of new multimedia systems, applications such as Internet Protocol Television (IPTV), Video Conferencing, Video on Demand (VoD) and IP Telephony are replacing very quickly the legacy systems.

This rapid growth raises questions about the provided Quality of Service. Using the video service as an example, people who use the traditional TV are used to a certain quality level provided by this service. Therefore, when these legacy systems are replaced by IPTV, the quality must be at least as good as in the old one.

All these new services are IP based and, consequently, are subject to the several constraints of an IP network such as bandwidth, packet loss, latency and jitter. Thus, to

address this problem, researchers created the concept of QoS. It is a term related with the capability of the system to provide a certain service quality, which can be achieved by employing resource reservation, queuing techniques, among other mechanisms. There are several metrics to evaluate the capabilities required to transmit data with special requirements in IP networks. Usually these metrics are closely related with the QoS needed by the applications.

The Internet Engineering Task Force (IETF) IP Performance Metrics (IPPM) [IETF, 2015] working group is developing a set of metrics that can be useful to measure the quality, performance and reliability of IP networks (e.g. Internet). The group has published documents to measure the one-way delay [Almes et al., 1999a], delay variation [Demichelis and Chimento, 2002], one-way packet loss [Almes et al., 1999b], and round-trip delay [Almes et al., 1999c].

The upcoming sections will present an overview of video applications, followed by presentation of the main video quality evaluation metrics.

2.1.2.2 Video Applications

This section presents the video applications, which includes a general overview about video concepts and a brief description of the most popular video-based applications.

Video transmission requires high bandwidth, which is reduced through the use of adequate coding mechanisms. Currently, one of the most widely used codecs is H.264 [ITU-T, 2010], also known as MPEG-4 Part 10 or Advanced Video Coding (AVC), which was developed by the ISO/IEC Moving Pictures Experts Group (MPEG) and the ITU-T Video Coding Experts Group (VCEG). H.264 can provide the same quality as legacy MPEG-4 Part 2 but it only uses between one third to one half of the bandwidth.

This codec uses three distinct type of frames, such as I, P and B. The I-frames are the only independent frames. P-frames are predicted frames and depend on the previous I-frame. B-frames are bidirectional predicted frames and depend on both the I and P frames. The only optional frames are the B-frames. Moreover, MPEG-4 combines all the frames in a Group of Pictures (GOP), which consists of a single I-frame, various P-frames and, if required, the corresponding B-frames. Figure 2.3 illustrates the GOP structure for H.264 / MPEG-4 AVC.

H.264 is used in High-Definition Television (HDTV) and it is also an optional codec in the ITU-T H.323 [ITU-T, 2013] recommendation, which is the main and widely deployed [H323forum, 2015] recommendation for audio-visual communica-

2. Related Work

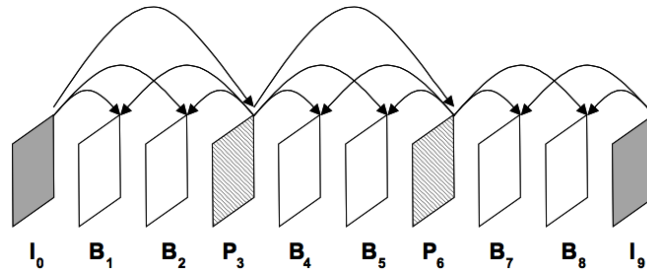

Figure 2.3: GOP structure for H.264/MPEG-4 AVC
(Source [Apostolopoulos et al., 2002])

tion in packet-based networks. A detailed analysis of the performance and complexity of H.264/MPEG-4 AVC is shown in [Ostermann et al., 2004]. Wiegand et al. have analyzed its standard implementation and architecture in detail, and made comparisons with the most popular legacy video compression standards, such as H.263, MPEG-2 and MPEG-4 [ITU-T, 2010][Wiegand et al., 2003].

There are two main types of video applications, namely the non-interactive and the interactive ones. The former are applications where the users only receive the video and otherwise do not interact. The applications that have these characteristics are less vulnerable to the network delay and packet loss, as the usage of buffering mechanisms and error control protocols might prevent a high degradation in the user experience. Nonetheless, its bandwidth requirements are usually higher than those of other video systems. With the latter applications, due to the interactivity, there is a need of low delay, jitter and packet loss. A brief description of some of the most used interactive and non-interactive video applications is given next.

Non-interactive Video Applications

High-Definition Television. The High-Definition Television (HDTV) refers to the TV streaming using high definition format (i.e. 1920x1080 pixels with 24 frames per second). In these system, the video compression assumes a particular importance, since the used bandwidth is one of the big issues in the HDTV transmissions. Besides the high bandwidth required by each channel, usually a user is not only requesting a single channel.

Video on Demand. Video on Demand (VoD) is a system where the user is able to request specific content. It has requirements similar to HDTV if the video quality is near high definition format. Nonetheless, in these systems the user can choose the

content and, in some cases, the content quality, and perform actions like *pause/stop*.

Video streaming. Video streaming is the most popular way of streaming video over the internet. The popularity of video streaming was catalyzed by the strong presence of many video streaming specialized websites (e.g. YouTube).

Video broadcasting. The video broadcasting is related to the mass transmission of video. There are high similarities between video streaming and video broadcasting, but while video streaming is performed from a stored video/file the video broadcasting usually refers to real-time transmissions. The real-time factor raises new challenges, namely the capability of supporting many users at the same time, while keeping the quality at good levels.

Interactive Video Applications

Videoconferencing. The videoconferencing systems are composed by a set of standards that aim at enabling the communication between two or more locations, transmitting video, audio and data simultaneously. The main applications are the meetings between people geographically distributed, also including others, such as education or medicine.

Telemedicine. Telemedicine systems are a particular, and important, use case of the videoconferencing systems that allow the remote interaction between a patient and a doctor. It can also be used to perform some exams at remote locations (e.g. ultrasounds), and allows the doctor to see the results in real time.

E-learning. The employment of specific videoconferencing techniques to the e-learning allows communication from both tutor and class, and in some cases the usage of virtual boards.

The following section introduces the main video quality evaluation metrics.

2.1.2.3 Quality Evaluation

This section presents the metrics and methods to evaluate video applications' quality over the network. Besides presenting some of the most used algorithms and mathematical models to evaluate video applications, some subjective schemes are also introduced.

2. Related Work

ITU-T F.700 Framework

The ITU-T F.700 framework defined a subjective scale to perform video quality evaluation, which is divided five main groups [ITU-T, 2000a], from the reasonable quality to detect movement up to the high definition required from HDTV. The evaluation scale for video is defined as follows:

- ▶ **Level V(-1):** video signal sufficient to allow movement to be detected;
- ▶ **Level V0:** minimum videophone quality, sufficient for showing the head of one person so that his identity and his facial expressions may be recognized; the amount of movement that can be tolerated without degraded temporal performance is very limited;
- ▶ **Level V1:** basic videophone quality, sufficient for showing a head and shoulder view of one person while being able to observe the lips movements; the amount of movements is limited to those of a seated person in a normal conversation;
- ▶ **Level V2:** basic videoconference quality, allowing a small group of three seated persons to be shown simultaneously; the amount of movements is limited to those of a normal discussion;
- ▶ **Level V3:** television broadcasting quality;
- ▶ **Level V4:** high definition television quality.

Table 2.1 shows some examples of applications classified with the quality levels proposed in the ITU-T Recommendation F.700 [ITU-T, 2000a].

Service	Level V0	Level V1	Level V2	Level V3	Level V4
PSTN videotelephone	x				
Mobile videotelephone	x	x	x		
Videoconference		x	x	x	
Video surveillance				x	x
Video distribution				x	x

Table 2.1: Quality level requirements for common video application
(Source [ITU-T, 2000a]).

As illustrated, for the same service / application the required level can have different values. This variance is due to the quality provided by the services, which can be higher in some situations.

Mean Opinion Score

The more popular way to measure the applications quality is using the Mean Opinion Score (MOS) [ITU-T, 1996] metric. The MOS is a sensorial metric, which requires humans to evaluate the quality in a scale from 1 (bad quality) to 5 (excellent quality). This score is calculated based on the perceived quality, and results are presented as an average quality. Table 2.2 shows the perceived quality by the end-user and each correspondent score, which is not limited to an integer value, i.e., the quality grade can be a real number in the middle of the different stated quality levels.

Perceived quality	Score
Bad	1
Poor	2
Fair	3
Good	4
Excellent	5

Table 2.2: Mean Opinion Score quality score scale
(Source [ITU-T, 1996])

MOS evaluation is mostly associated with voice services, but as a subjective metric it can also be applied to the video-based applications. Even having already shown efficient results, the MOS is being replaced by computational-based evaluations, as it is based on human perception of the system and it is hard to main a system with such characteristics. Some objective evaluations methods will be described next.

Peak Signal to Noise Ratio

The Peak Signal to Noise Ratio (PSNR) is an objective evaluation metric that represents the ratio between the signal power and the noise power, which affects the original signal. In the context of video evaluation, the original signal is the original video and the noise is the error introduced by compression algorithms / CODECs, losses in the network and other problems in the video delivery.

2. Related Work

The calculation of PSNR, shown in Equation 2.2, is based on the Mean Squared Error (MSE) metric (Equation 2.1), but it uses a logarithmic scale. A lower PSNR means low quality, i.e., the original image has PSNR equal to zero.

$$MSE = \sum_{i=1}^x \sum_{j=1}^y \frac{(|A_{(i,j)} - B_{(i,j)}|)^2}{x \times y} \quad (2.1)$$

$$PSNR(dB) = 10 \times \log_{10} \left(\frac{MAX^2}{MSE} \right) \quad (2.2)$$

where

MAX	The maximum fluctuation of the input image pixel (e.g.)
A and B	One of the images to be evaluated
x	Image width
y	Image height
$x \times y$	Number of pixels

This widely deployed metric is usually converted into a MOS scale, which enables a fast understanding of the results to many users. However, the PSNR has several problems regarding the quality perceived by the end users. Figure 2.4 shows two images with the same PSNR, nonetheless it is noticeable that the image on the right has worst quality.



Figure 2.4: PSNR error examples: both images have the same PSNR.
(Source [Winkler and Mohandas, 2008])

The bad performance of the PSNR metric is related with the different sensibility of the human vision, namely because this type of metric (also known as data metrics) is distortion-agnostic and content-agnostic. The former property is related with the distortion type and properties (e.g. the human vision is not sensitive to high frequency distortions). The latter, content-agnostic, is associated with the place where the distortion occurs (e.g. if the distortion is in the sky it will have less impact in the subjective quality than in the tower) [Winkler and Mohandas, 2008].

Structural Similarity

Structural Similarity (SSIM) Index [Wang et al., 2004] is an objective and full reference image quality metric, which measures the similarity between two images and it is based on three different similarity components, namely the contrast, the luminance and the structural similarity. Unlike PSNR, which is incoherent with Human Visual System (HVS) characteristics, such as human eye perception, SSIM takes into consideration human eye perception parameters, which improves evaluation accuracy. Equation 2.3 illustrates the general form of the SSIM index, encompassing the three main components previously described.

$$SSIM(x, y) = [c(x, y)]^\alpha \times [l(x, y)]^\beta \times [s(x, y)]^\gamma \quad (2.3)$$

where

c	Luminance comparison of the signals
l	Contrast comparison of the signals
s	Structure comparison of the signals
x and y	Two non-negative image signals
α, β, γ	Weight / importance of each component

The resulting SSIM Index is a combination of the three similarity parameters into a single value between 0 and 1, where 0 means no correlation with the original image, and 1 means the exact same image.

2. Related Work

Figure 2.5 illustrates two images with the same PSNR. It is possible to observe that Figure 2.5 *a*) is clearly better than 2.5 *b*), since the latter has strong blurring effect.

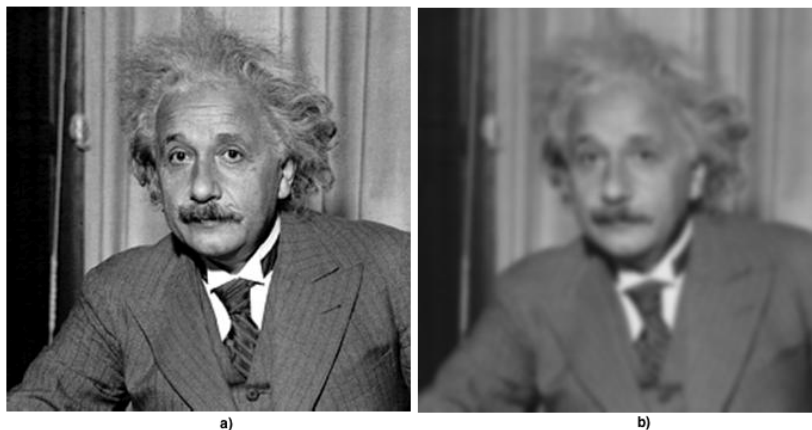

Figure 2.5: Accuracy comparison between SSIM and PSNR
(Source [Wang et al., 2015])

By applying SSIM to both images, the results were completely different. Since SSIM was able to distinguish the quality of the images, Figure 2.5 *a*) has SSIM = 0.988 (almost equal to the original), while Figure 2.5 *b*) has SSIM of only 0.694. This is a considerable accuracy improvement, while compared with PSNR. SSIM has also shown good results with different public images galleries, and it performs well not only detecting problems related with the compression algorithm, but it is also able to detect problems created by some artifact (e.g. noise) [Winkler, 2007].

Video Quality Metric

The Video Quality Metric (VQM) [Pinson and Wolf, 2004] is a standardized objective video evaluation method developed by the National Telecommunications and Information Administration (NTIA). Figure 2.6 illustrates the general model proposed by NTIA as a video quality measure standard. One of the key elements in the model is the calibration process, which includes the spatial and temporal alignments, valid region estimate, and gain / level offset calculation in both original and processed video streams. Besides the calibration process, VQM also includes the computation of desired video quality parameters.

The Video Quality Experts Group (VQEG) is an independent group of video experts that have developed various data sets to perform video quality techniques evaluation. VQM general model uses reduced-reference technology [ITU-T, 2000b], which

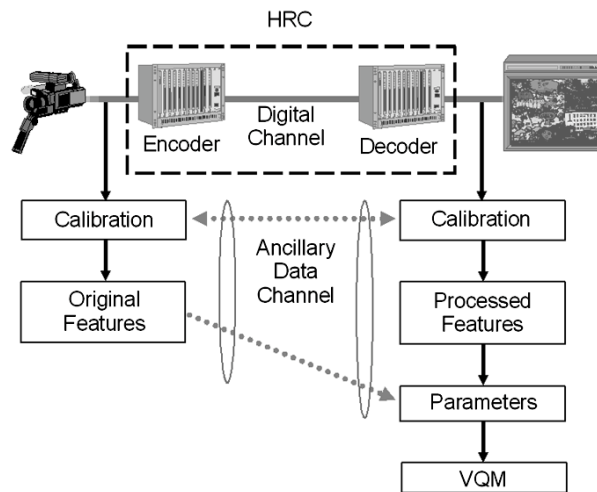

Figure 2.6: VQM general model
(Source [Pinson and Wolf, 2004])

enables the possibility of good evaluation in near real-time video. It has also a very good performance in the VQEG Phase II Full Reference Television tests [VQEG, 2015], and was accepted as a standard by the American National Standards Institute (ANSI) (ANSI T1.801.03-2003) and later internationally approved by ITU recommendations ITU-T J.144 and ITU-R BT.1683.

Perceptual Evaluation of Video Quality

Perceptual Evaluation of Video Quality (PEVQ) [PEVQ, 2015] is an objective video metric, able to report the quality perceived by the end-user, where the output is expressed in terms of MOS. The algorithm used in the PEVQ is a full reference algorithm, and due to the very good results in the VQEG independent tests it became part of the ITU-T Recommendation J.247 [ITU-T, 2008]. The general architecture of PEVQ is presented in Figure 2.7.

Firstly a spatial and temporal alignment is performed, followed by the calculation of the perceptual difference between the images, which takes into consideration the human eye characteristics. The next phase, the distortion classification, is responsible for the detection of some distortions based on the indicators received from the perceptual difference phase. In the final step, the results from distortions are aggregated to provide the final MOS. Besides the final MOS, the PEVQ reports also some indicators,

2. Related Work

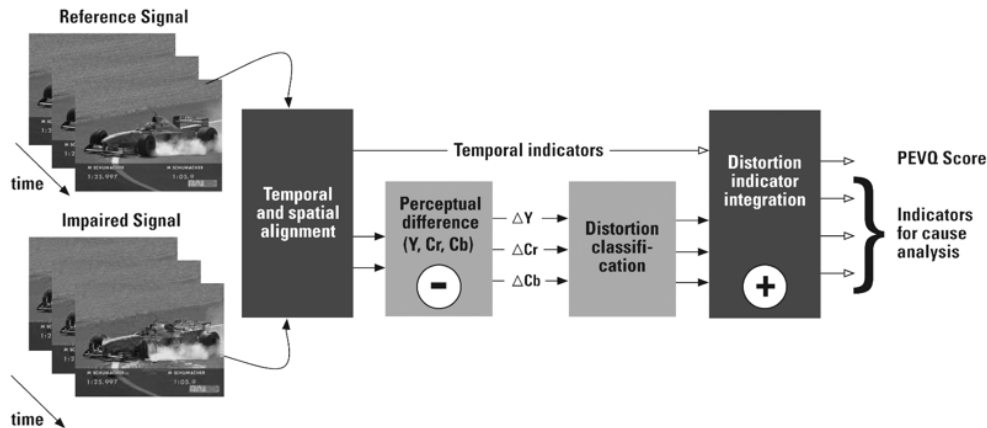

Figure 2.7: Perceptual Evaluation of Video Quality metric overview
(Source [PEVQ, 2015])

which can be used to have a deeper idea about the obtained MOS. These indicators include some other metrics, such as PSNR, contrast, blur, blockiness, and delay.

Pseudo-Subjective Quality Assessment

The Pseudo-Subjective Quality Assessment (PSQA) [Rubino, 2005] is a video subjective evaluation methodology based on a random neural network. Therefore it requires the typical phases of these approaches, namely configuration, training and validation. The phase involves the parameters' adjustment. The authors have used the loss rate and the mean loss burst size at application frame level. During the training phase the network must be prepared to evaluate the video quality, and the authors asked a panel of humans to report on the quality. On one hand, the results should be accurate if the human panel is well balanced and coherent, but on the other hand it represents a huge drawback, since the presence of the humans in the system does not allow an efficient adaptation to new contexts, and it can also generate false results if they do not represent a good sample. The authors argue that it is not a problem, because the training phase must be done only once. However, the trained network will only be able to work with these specific videos - this will depend on the distortion and problems introduced during the training phase, which may take long to ensure good performance. The latter phase, the validation, is where the resulting function from the training is evaluated, and if it is not good the training should be repeated.

2.2 Video Transmission Energy Consumption and Quality Assessment in IEEE 802.11 Wireless Networks

This section discusses the key issues involved in the empirical assessment of video transmission energy consumption and quality over wireless networks. First, the most relevant assessment requirements are identified, followed by the related work analysis and discussion.

The study of energy-efficiency video transmission communication for portable devices, where the battery lifetime is one of the major constraints, assumes an important role in the acceptance of those devices. Therefore, various works in the literature have addressed this problem by employing an empirical approach, ranging from basic energy assessment testbeds to more complex energy-aware evaluation methodologies. Concerning the video assessment, it is important to assess not only the typical network level QoS metrics, but also to have mechanisms able to evaluate the Quality of Experience perceived by the end-users. The most relevant video quality evaluation concepts and metrics were already introduced in Section 2.1.2.

Although there are various approaches in the literature addressing this subject, there is a gap concerning the systematic identification of the core requirements that should be fulfilled to guarantee an accurate and realistic assessment of video transmission energy consumption and quality.

To simplify the analysis, the identified features were grouped into three distinct main subjects, namely evaluation environment, energy consumption assessment, and quality assessment. These features, including a brief description, are presented as follows:

⇒ Evaluation environment:

- *Testbed assessment*: the assessment should be done in a testbed, in order to accurately measure the impact on real life systems;
- *Configurable network conditions*: the capability to perform assessments within heterogeneous network conditions (e.g., random losses or limited bandwidth), enabling the emulation of distinct network characteristics;
- *Batch tests*: since statistical significance of the attained results is mandatory, it is crucial to have mechanisms that allow batch test processing;
- *Easy configuration*: as the measurement methodology or framework might be used by users with different backgrounds, it is important to

2. Related Work

provide easy configuration of the evaluation environment, namely by using configuration files (e.g., XML) or similar approaches.

⇒ Energy consumption assessment:

- *High precision*: to guarantee a good accuracy of energy consumption related values, it is vital to employ hardware capable to provide high resolution energy measurements;
- *Focused measurement*: the measurements should be performed only on the network cards, to accurately study energy consumption in wireless systems;
- *Technology independent*: the assessment approach must be technology independent, which can guarantee its usage and accuracy with distinct wireless access technologies.

⇒ Quality assessment:

- *Quality of Experience (QoE) assessment*: the assessment of Quality of Experience perceived by the end-users is very important to understand the real impact of the video related optimization techniques;
- *Quality of Service (QoS) assessment*: the use of network level metrics is needed to complement QoE assessment and to provide insights on global network performance;
- *Thorough metrics*: the evaluation should encompass multiple metrics, to allow the assessment of quality from different perspectives, by using distinct QoE and QoS metrics.

These requirements will drive the analysis of related work presented next, towards the identification of the open issues about the assessment of energy-efficient video transmission.

Balasubramanian et al. [Balasubramanian et al., 2009] have studied energy consumption in mobile phones with multiple network interfaces. The main goal was to evaluate the energy efficiency of 3G, GSM and WiFi. Their main contribution is a protocol that reduces energy consumption of applications by scheduling transmissions. Wang and Manner [Wang and Manner, 2010] used an Android-based phone, and tested the energy consumption by means of Enhanced Data rates for Global Evolution (EDGE), High Speed Packet Access (HSPA) and IEEE 802.11 wireless technologies. The effects of packet size and packet rate were addressed in the study, but only

the total energy consumed by the device was measured, which is a serious drawback when trying to optimize the network protocols or applications.

Rice and Hay [Rice and Hay, 2010] proposed a methodology to measure the energy consumption of IEEE 802.11 interfaces in mobile phones, by replacing the battery with a personalized plastic battery holder; this allows an accurate measurement to be made within the telephone “real energy” circuit. The measurement system also employs a high-precision resistor to prevent rapid changes in energy consumption caused by the high-frequency components of the mobile phones. The study encompasses batch test operations with different mobile phones. While this study is able to measure energy consumption of mobile phones accurately, it is not able to carry out a precise evaluation of the impact of IEEE 802.11 on mobile phones. The reason for this is that the various mobile phones tested have different behaviors, particularly when employing different operating systems or hardware. The energy consumption while receiving video over User Datagram Protocol (UDP) and Transmission Control Protocol (TCP) in Android devices has been addressed by Trestian et al. [Trestian et al., 2012]. The authors conducted a study encompassing the analysis of network-related parameters in the device’s power consumption when receiving video. Although this study reports both QoS and QoE metrics in the video assessment, it does not include a high-precision measurement facility, neither a technology independent assessment with easy configuration allowing batch tests.

Shih et al. [Shih et al., 2002] have developed a technique to increase the battery lifetime when VoIP calls are made. The proposed technique is able to shut down the wireless card/radio when it is not in use. Although this technique was designed to a specific application (i.e., VoIP), it has the potential to allow the network interface states (e.g. idle or sleep) to be analyzed so that other applications can be adapted accordingly. Following the need to better understand the impact of application design in the energy consumption, Vergara and Nadjm-Tehrani have proposed the Energy-Box [Vergara and Nadjm-Tehrani, 2013] framework. The main goal of EnergyBox is to enable an accurate energy consumption estimation of data transmission. The application data pattern can be given by capturing the real network traffic or by using a synthetic traffic generation tool. EnergyBox also uses specific information about the wireless network interface in use and allows the configuration of device power levels. The proposed tool was validated with real hardware and showed an accuracy between 93-99% for WiFi and 94-99% for 3G. Even though EnergyBox can help the developers to improve and validate energy-aware solutions, it cannot provide energy consumption information specific of the network interface. Furthermore, as the tool

2. Related Work

uses information about the technology energy states, is it dependent on the wireless technology used, and it does not provide any Quality of Experience assessment.

Li et al. [Li et al., 2009] have conducted a study of energy-efficient video transmission over a wireless link, by controlling the parameters associated with physical and link layers. The results showed energy savings of around 38% for a CDMA system supporting six users. However, the assessment was entirely based on simulations, which do not accurately reflect real systems behaviors. Other simulation studies have proposed energy-efficiency approaches for video transmission based on scalable video coding features, using content-aware rate control techniques [Lee et al., 2010] and cooperative video transmission with end-to-end statistical Quality of Service provisioning [Abdel Khalek and Dawy, 2011]. The mobile video services energy consumption using both IEEE 802.11 and cellular network access was also studied by Hoque et al. [Hoque et al., 2013]. The assessment was performed in a testbed, and includes the usage of three distinct video streaming services and six distinct mobile phones. The attained results show that energy performance of mobile phones when receiving video streaming is not optimal, and various optimization suggestions are given. In fact, the results show the importance of have a way to measure both quality and energy consumption, in a integrated way, regardless of the access technology.

Yuan et al. [Yuan et al., 2006] have employed cross-layer techniques to improve multimedia application quality, while keeping battery energy consumption at a minimum. The proposed cross-layer solution was validated in a testbed with the aid of a digital oscilloscope for an assessment of energy related factors, but did not take into account the impact of the approach on end-user perceived quality. The evolution of video quality metrics has shown the importance of making an accurate assessment of end-user QoE [Winkler and Mohandas, 2008]. Many researchers have studied how transmitting video under different network conditions affects the perceptions of end-users, but without focusing on energy consumption [De Moor et al., 2010][Bernardo et al., 2009].

A qualitative assessment study of the reviewed literature, taking into account the already defined requirements, was performed. The main goal was to assess the related works capability to fulfill the needs to support an accurate and realistic assessment approach for video transmission energy consumption and quality. Table 2.3 summarizes the findings, by qualitatively analyzing the availability of the relevant features in each work. The check mark (✓) means that the work has such feature, while the cross (✗) says that it is not available. Moreover, if the feature is completely out of scope of the work (e.g., a work does not take into account any energy related issue) it is marked

2.2 Video Transmission Energy Consumption and Quality Assessment in IEEE 802.11 Wireless Networks

with a square symbol (■).

Table 2.3: Related work analysis summary

Work	Evaluation environment				Energy consumption assessment			Quality assessment		
	Testbed	Config. net cond.	Batch tests	Easy config.	High precision	Focused measur.	Tech indep.	QoE	QoS	Thorough metrics
[Balasubramanian et al., 2009]	✓	✗	✗	✗	✓	✗	✓	✗	✗	✗
[Wang and Manner, 2010]	✓	✗	✗	✗	✓	✗	✗	✗	✓	✗
[Rice and Hay, 2010]	✓	✗	✓	✗	✓	✗	✗	✗	✗	✗
[Trestian et al., 2012]	✓	✗	✗	■	✓	✗	✗	✓	✓	✓
[Shih et al., 2002]	✓	✗	✗	✗	✓	✓	✓	✗	✗	✗
[Vergara and Nadjm-Tehrani, 2013]	✓	✗	✓	■	✓	✗	✗	✗	✗	✗
[Li et al., 2009]	✗	✓	✓	■	■	■	■	✗	✓	✗
[Lee et al., 2010]	✗	✓	✓	■	■	■	■	✗	✓	✗
[Abdel Khalek and Dawy, 2011]	✗	✓	✓	■	■	■	■	✗	✓	✗
[Hoque et al., 2013]	✓	✗	✗	■	✓	✗	✗	✗	✓	✗
[Yuan et al., 2006]	✓	✗	✗	✗	✓	✗	✗	✗	✗	✗
[De Moor et al., 2010]	✓	✗	✗	✗	■	■	■	✓	✓	✗
[Bernardo et al., 2009]	✓	✗	✗	✗	■	■	■	✓	✓	✗

Legend: ✓ = Available feature ; ✗ = Not available feature ; ■ = Out of scope

The empirical energy consumption measurements have been addressed in the literature mainly by measuring the total energy consumption of end-user devices. Although these techniques can be a feasible approach to analyze these systems as a whole, they do not focus on the energy consumption of the network interface and consequently they are not able to measure only the energy consumed by the MAC and PHY layers. Accurate energy measurements at the lower layers enable the possibility to establish important relationships between the application network design and the energy spent.

Nevertheless, the state-of-the-art analysis also showed that there is a clear gap in the literature concerning the unified experimental evaluation of video energy-efficiency assessment, with multiple works considering only energy consumption or quality evaluation as main goal. Therefore, there is the need to propose an integrated empirical framework able to assess video transmission energy consumption and quality, while considering all the core requirements previously identified. Besides being an asset to validate and evaluate novel energy-aware video streaming algorithms and approaches, a framework fulfilling all the identified requirements can also play a key role in the design of realistic simulation models.

Further discussion regarding the proposal and design of a framework fulfilling the identified required is performed in Chapter 3. Additionally, Chapter 6 discusses the empirical assessment of energy consumption in Android mobile devices.

2.3 IEEE 802.11 Energy Efficiency Improvements for Continuous Media Applications

This section presents the most relevant related work concerning IEEE 802.11 energy efficiency improvements for Continuous Media Applications.

When analyzing the state of the art concerning energy saving mechanisms for IEEE 802.11, there are several occasions to consider cooperation between energy aware mechanisms at lower (e.g. MAC layer aggregation) and upper layers. As an example, the cooperation between frame aggregation and the native power save mechanisms in the IEEE 802.11 standard, namely Power Save Mode (Legacy-PSM) or Unscheduled Automatic Power Save Delivery, still is at an early research stage.

Trying to overcome this gap, Camps-Mur et al. [Camps-Mur et al., 2012] have studied the impact of IEEE 802.11 MAC layer aggregation on both PSM and U-APSD schemes. The authors proposed a Congestion Aware-Delayed Frame Aggregation (CA-DFA) algorithm, which is divided into two logical parts: congestion estimation and dynamic aggregator. Congestion estimation is responsible for assessing the network capabilities and uses these values as near real-time input for dynamic aggregation. Being able to measure accurately local network congestion, it allows the algorithm to dynamically adapt the maximum frame aggregation size when the network congestion goes below a certain limit. When compared with the IEEE 802.11 standard aggregation schemes, the CA-DFA performance is superior, particularly in terms of energy consumption. However, the CA-DFA algorithm does not support any end-user feedback.

Tan et al. [Tan et al., 2007] proposed a cross-layer mechanism based on the standard PSM, but using information provided by the upper layers. The algorithm, named PSM-throttling, aims at minimizing energy consumption for bulk data communications over IEEE 802.11. The PSM-throttling concept is based on the idea that there are already many Internet based applications performing bandwidth throttling and, as a result, there is an opportunity to improve energy efficiency at the client side. PSM-throttling uses the under-utilized bandwidth to improve the energy consumption of bandwidth throttling applications, such as video streaming. Nonetheless, it neither considers the inclusion of dynamic aggregation, nor the possibility that the end-user controls the maximum allowed delay. Ding et al. [Ding et al., 2012] also investigate the standard PSM capabilities and identify considerable differences between static and dynamic PSM approaches. By using preliminary results, the authors proposed a system named Percy, which uses the best of both static and dynamic methods.

2.3 IEEE 802.11 Energy Efficiency Improvements for Continuous Media Applications

The Percy proposal is deployed as a transparent web proxy in the access point, and its main idea is to buffer the information in the local proxy, while the clients are running the PSM algorithm. The Percy solution does not consider the end-user feedback or frame aggregation, which could boost the 40% energy savings reported by the authors. Moreover, the trace-driven evaluation conducted does not assess the impact of the proposed mechanism on the end-users quality of experience while receiving the application data.

An adaptive-buffer power save mechanism (AB-PSM) for mobile multimedia streaming was proposed by Adams and Muntean [Adams and Muntean, 2007] to maximize the station sleep period. The proposal includes an application buffer, able to hide the frames from the Access Point and, consequently, to avoid the TIM reports with pending traffic indication. The authors argue that the amount of packets to store in that buffer could be dynamic, but they do not explain how to overcome this issue. Moreover, AB-PSM aims to be an application-based approach, but the mechanism to be used by the station to provide feedback to the access point was not defined. Additionally, aggregation mechanisms were not employed and the testbed study is very limited, since only battery lifetime was analyzed. This is an important parameter, but it should always be correlated with the drawbacks introduced in the end-user application (e.g., extra delay or jitter). Another user-aware energy efficient streaming strategy for video application on smartphones was suggested by Shen and Qiu [Shen and Qiu, 2013]. The system was modeled as a stochastic process, and a Gaussian mixture model was built to forecast the end-user demands regarding the video playback time. The resulting predictive model enables a more efficient control of video download, allowing a superior control of the power states. The authors argue that energy savings of around 10% can be attained. Nevertheless, an important limitation regarding this stochastic approach is related to the need to have information about the actual user habits. Since the model uses end-user habits information as input, it is crucial that such historical information is always available. Additionally, the simulation study was performed using only a mathematical tool, where several network stack aspects are not modeled. Therefore, the obtained results are limited to the wasted energy, and do not include an analysis of network quality of service related parameters nor the end-users perceived quality.

According to Palit et al. [Palit et al., 2011] the feasibility of employing aggregation is strongly related with the scenario and/or application. In order to understand the typical packet distribution in a smartphone data communication, the authors have analyzed mobile device traffic. The main observations are that around 50% of the

2. Related Work

packets have a size less than 100 bytes and 40% have an inter-arrival time of 0.5ms or less. These conditions enable a good opportunity to perform aggregation. Using this motivation, the authors have studied the aggregation impact in the smartphones' energy consumption. The proposed aggregation scheme uses a buffering/queuing system in the AP together with PSM in the client side. The proposed packet aggregation mechanism, named Low Energy Data-packet Aggregation Scheme (LEDAS), receives packets from the different applications through the Logical Link Control sub-layer and performs the aggregation. This approach showed some good results, but application requirements, such as the maximum tolerable delay, were not taken into account.

Lorchat et Noel [Lorchat and Noel, 2005] have proposed to use frame aggregation to save energy. The main motivation for the work was the possibility to send small packets together, which can bring considerable energy savings, since the Ethernet MTU is 1500 bytes and the IEEE 802.11b/g MTU is 2272 bytes (and up to 7935 bytes in IEEE 802.11n), the employment of aggregation techniques can be useful. The implementation of the proposed aggregation scheme, similar to the A-MSDU approach in the IEEE 802.11n standard, shows energy-efficient benefits when using the proposed frame aggregation technique, but also highlights some costs. The work discusses possible energy costs of extra CPU and memory needed to perform the aggregation. The authors argue that frame aggregation employment must take into account the current bit error rate in the channel, because re-transmission might have higher energy cost than transmitting each single frame. However, aggregation can also bring some benefits for error-prone scenarios, since the number of frames being sent is lower and, as a result, the number of medium collisions will tend to be lower.

Lin et al. [Lin and Wong, 2006] studied the new A-MPDU aggregation mechanism of the IEEE 802.11n standard, aiming at proposing an optimal frame size adaptation algorithm. There is a clear trade-off between throughput and delay performance when employing aggregation. The attained results show the positive impact in both throughput and delay when using the developed adaptive frame aggregation algorithm compared with fixed and random aggregation sizes. Moreover, the simulation outcomes also underline the strong correlation between the bit error rate and the optimal aggregation size. Other enhanced A-MSDU frame aggregation schemes for IEEE 802.11n was proposed by Saif et al. [Saif et al., 2012], aiming at reducing the aggregation headers originally proposed in the standard. The new aggregation scheme, called mA-MSDU, uses as main motivation the need to introduce an additional new header for each sub-frame sent when using the standard A-MSDU. Considering the presented

2.3 IEEE 802.11 Energy Efficiency Improvements for Continuous Media Applications

results, the suggested dynamic selection of the aggregation method has some advantages when compared with the single usage of A-MSDU or A-MPDU, even employing dynamic aggregation size.

Kennedy et. al studied the adaptive energy optimization mechanism for multi-media centric wireless devices [Kennedy et al., 2012] and concluded that significant energy saving could be achieved when performing application-aware optimization. Pathak et al. [Pathak et al., 2012] have proposed an application level energy consumption profiling tool for mobile phones and reported issues concerning high energy usage in I/O operations. The software-based energy methodologies were early surveyed by Kshirasagar [Naik, 2010].

Although others in the literature [Adams and Muntean, 2007][Dogar et al., 2010] have also proposed energy optimization for continuous media applications, none takes advantage of all the key optimization parameters identified, as summarized in Table 2.4.

Table 2.4: Related work summary

Work	Buffering Techniques	Frame Aggregation	End-user feedback	QoE assessment
[Camps-Mur et al., 2012]	✓	✓	✗	✗
[Tan et al., 2007]	✓	✗	✗	✗
[Ding et al., 2012]	✓	✗	✗	✗
[Adams and Muntean, 2007]	✓	✗	✓	✗
[Lorchat and Noel, 2005]	✗	✓	✗	✗
[Lin and Wong, 2006]	✗	✓	✗	✗
[Saif et al., 2012]	✗	✓	✗	✗
[Shen and Qiu, 2013]	✓	✗	✓	✗
[Palit et al., 2011]	✓	✓	✗	✗
[Dogar et al., 2010]	✓	✗	✗	✗

Legend: ✓ = Yes ; ✗ = No

One can observe that there is a lack of an approach designed to enhance power saving for continuous media applications, by combining the usage of buffering techniques and frame aggregation mechanisms, while using the end-user feedback to keep the application quality within the defined limits. Additionally, although the novel power saving modes are available in more recent IEEE 802.11 standards, the Power Save Mode (Legacy-PSM) is still the *de facto* standard algorithm concerning PSM in IEEE 802.11, while the implementation of other algorithms is mainly optional. As a result, an algorithm enhancing the widely deployed IEEE 802.11 Legacy-PSM, while being fully compliant with the original standard, is desired. This open issue will be further addressed in Chapter 4.

2.4 Summary

This chapter has introduced the basic concepts of IEEE 802.11 standard, together with an overview of multimedia video applications and their quality assessment. Additionally, a literature review regarding the assessment of video transmission energy consumption and quality has been performed. Lately, the most relevant IEEE 802.11 energy efficiency improvements for Continuous Media Applications have been analyzed.

IEEE 802.11 stands as the *de facto* standard for Wireless Local Area Networks access, motivating its constant improvement. During the last years various IEEE 802.11 amendments have been released targeting distinct goals. Apart from Physical Layer layer optimization, also the Medium Access Control layer has been improved along with the standard evolution, namely to support aggregation and enable superior power saving capabilities.

An overview of video transmission in wireless networks has also been given in this chapter, followed by the analysis concerning the most relevant video quality assessment metrics. The discussed metrics showed various possibilities to enable an accurate video quality assessment.

The core requirements to perform an accurate and realistic assessment of video transmission energy consumption and quality has also been defined. Thereafter, the related work analysis taking into account such requirements has been performed. This investigation concluded that there is a need to have an integrated methodology being able to accurately assess, in a combined way, both energy consumption and quality perceived by the end-users. Finally, this chapter presents the state-of-the-art regarding the IEEE 802.11 energy efficiency improvements for Continuous Media Applications. This discussion highlighted the need to have an energy-aware mechanism, which is able to consider the end-user feedback.

*— The greatest challenge to any
thinker is stating the problem in
a way that will allow a solution*

Bertrand Russell

3

An Evaluation Framework to assess Video Transmission Energy Consumption and Quality

THIS chapter proposes EViTEQ, an Evaluation framework to assess Video Transmission Energy consumption and Quality. Section 3.1 presents a brief introduction to the video energy consumption and quality evaluation subject. Section 3.2 describes the framework design, followed by the presentation of the results attained in the assessment of video quality of experience and network energy consumption using the proposed framework in Section 3.3. Section 3.4 investigates the energy consumption in wireless access networks using the EViTEQ framework. Finally, Section 3.5 summarizes the chapter.

3. An Evaluation Framework to assess Video Transmission Energy Consumption and Quality

3.1 Introduction

Over the past few years multimedia services and applications, such as IPTV and VoD, have been replacing legacy systems and started to represent a considerable amount of the overall Internet traffic. The growing amount of multimedia traffic raises new challenges for access technologies, since these applications have higher network requirements. Besides the concerns about the quality of video traffic, energy consumption has also become an important quality perception parameter for end-users. Thus, the possibility to assess video energy consumption and quality simultaneously, became imperative for both operators and users.

As discussed during literature review in Section 2.2, most research work in this subject has been focused on the assessment of isolated parameters, lacking a combined study of both Quality of Experience and energy performance of multimedia applications. Aiming at fulfilling the identified gap, this chapter proposes the EViTEQ framework. The empirical analysis performed with EViTEQ in a real testbed showed the importance of an integrated and multi-featured evaluation. Furthermore, the EViTEQ framework has been employed to perform an investigation concerning the energy consumption of wireless access networks, using IEEE 802.11 as case study.

3.2 EViTEQ: Evaluation framework to assess Video Transmission Energy consumption and Quality

This section describes the framework designed for assessing video quality and energy consumption. The framework aims to address the end-user perceived Quality of Experience and the energy consumption of the video traffic together. First of all, the framework must be able to assess the Quality of Experience by including metrics for evaluating distinct video streaming end-user perceived quality and establishing the relationship of these metrics with energy consumption values.

With regard to the assessment of energy consumption, it is essential for high-precision energy consumption measurement to be carried out for each transmitted video. The question of accuracy is of crucial importance and a type of hardware must be used that is able to support multiple samples per second, since energy in small devices (i.e. network interfaces) tends to undergo slight variations over a period of time. Moreover, an independent technology evaluation is required to allow a comparison between different wireless technologies (e.g. IEEE 802.11 vs Long Term Evolution (LTE)). In the final stage of the technologically-related study, the framework should

3.2 EViTEQ: Evaluation framework to assess Video Transmission Energy consumption and Quality

also enable video streaming and energy consumption to occur under variable, but controlled and repeatable, network conditions.

The following subsections are structured as follows. Subsection 3.2.1 describes the framework core components, while the network configuration scheme is outlined in Subsection 3.2.2. Finally, the assessment metrics are discussed in Subsection 3.2.3.

3.2.1 Core Components

The proposed framework has three main components: video traffic generation, energy measurement and network configuration, as depicted in Figure 3.1. The following subsections describe the different parts of the framework in detail.

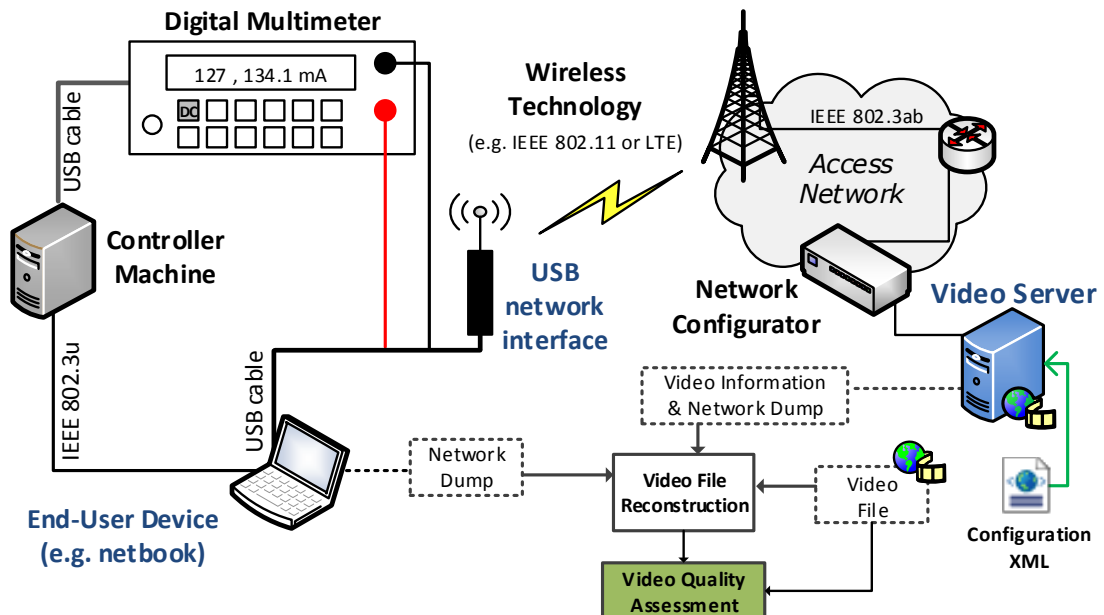

Figure 3.1: Architecture of the framework

3.2.1.1 Video Traffic Generation

The video traffic generation is performed using a server / client logic, where there is a “Video Server” entity transmitting video streaming to a certain “End-user Device”. First, the raw video data compression must be performed, where a raw lossless YUV video is compressed so that it can be sent to the end-user. The codec that will be used and all the compression tools should be selected in accordance with the specific requirements of the assessment goals and framework.

3. An Evaluation Framework to assess Video Transmission Energy Consumption and Quality

As well as supplying a set of scripts to prepare the video compression, the proposed framework also provides the tools and scripts required to start all the procedures for the video streaming. Each configuration can be saved in an Extensible Markup Language (XML) format, which allows configuration reuse and rapid parameter changes. Additionally, the proposed framework allows to configure the number of repetitions that have to be performed, and thus enables an improved statistical analysis to be conducted of all the results that have been obtained.

When the sender (i.e., “*Video Server*”) starts the transmission it will simultaneously begin the information gathering about the transmitted video. The same network capture is repeated at the receiver side until the video transmission ends. The network information about the transmitted packets is collected using the tcpdump tool [tcpdump, 2015].

The specific features of video streaming, such as frame types and sending times, are collected with the aid of the Evalvid [Klaue et al., 2003] tool. Moreover, Evalvid has the ability to reconstruct the received video, even when some frames have been lost. The proposed framework is designed to work together with Evalvid, but is not restricted to it. For instance, other similar video transmission and reconstruction tools such as Video Tester [Ucar et al., 2012] can also be used with slight changes in the framework’s scripts and procedures.

When all the video and network information has been collected from both the sender and receiver, the video is reconstructed frame by frame by using the collected information and the source video file. Thus, the reconstructed coded video is transformed back into a raw YUV format, so that it can be compared with the original *lossless* raw YUV video. The tools and metrics used to perform video quality assessment will be discussed later in this section.

3.2.1.2 Energy Measurement

The energy measurement facility was designed to meet all the requirements mentioned earlier, with a special focus on accuracy. It also provided an opportunity to automatize all the tests and to allow an assessment of different wireless network technologies by making only essential changes to the real-time hardware systems.

The first choice was to use an external Universal Serial Bus (USB) network interface, since it is able to give accurate measurements of the energy consumed solely by the interface, as desired. One of the main concerns that has already been reported in previous studies on energy measurement is the need to provide the system with

3.2 EViTEQ: Evaluation framework to assess Video Transmission Energy consumption and Quality

a stable and continuous voltage [Wang and Manner, 2010][Rice and Hay, 2010]. The impact on the voltage obtained by connecting the USB network interface directly to an end-user device was noticeable to a small degree in the preliminary tests. To overcome this limitation, the USB network interface was connected to an external AC powered USB hub, which was able to stabilize the system. The analysis regarding the voltage obtained when employing the external USB hub has shown voltage drops that are always lower than 1% of the total employed voltage, which is negligible in the overall analysis of the system.

Figure 3.2 shows the equipment used in energy measurement. As well as the end-user device, the measurement configuration includes a “Controller Machine” and a high-precision digital multimeter. The digital multimeter is a Rigol DM3061 with a maximum sampling rate of 50K samples/second and a test resolution of 6 1/2 digits. This multimeter is able to receive Standard Commands for Programmable Instruments (SCPI) commands (defined by IEEE 488.2 [IEEE, 2004]) and implements the Universal Serial Bus Test and Measurement Class Specification (USBTMC) standard interface.

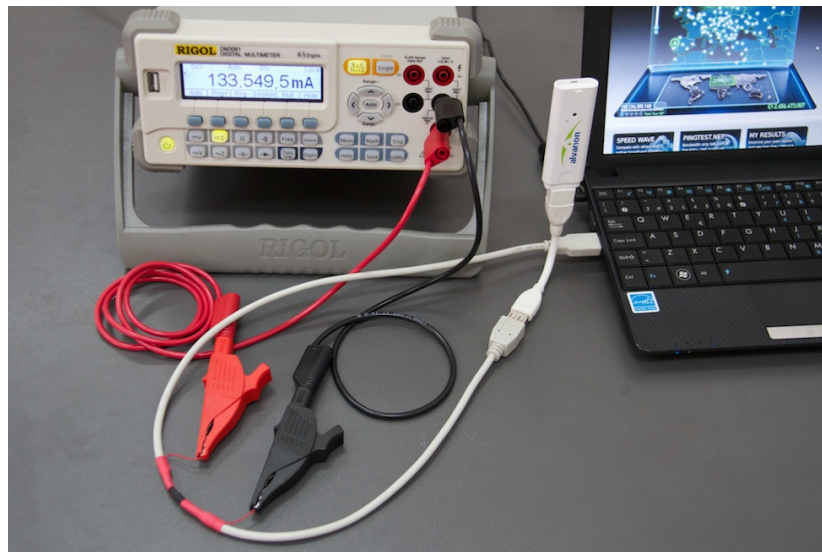

Figure 3.2: Details of the energy measurement testbed

By using SCPI commands and USBTMC, the “Controller Machine” is able to control and manage the digital multimeter, which enables accurate and repeatable tests to be conducted. The “Controller Machine” is also connected to the end-user device. This entity provides a fast and reliable point to control the experiments that must be performed and to collect all the resulting data from the digital multimeter. Since the voltage is stable, all the measurements concerning energy were estimated by collect-

3. An Evaluation Framework to assess Video Transmission Energy Consumption and Quality

ing the current values. The USB cable was intercepted in the common-collector voltage (VCC) cable (i.e. +5 VDC), as depicted in Figure 3.2.

3.2.2 Network Configuration

The challenges involved in assessing both video streaming quality and energy consumption are not restricted to the measurement techniques themselves, since the network configuration and conditions also play an important role in the process. Many studies in the literature only take account of nearly perfect network conditions, which may not correspond to the real conditions faced by an end-user when using the system on a daily basis.

The proposed assessment framework allows several network conditions to be emulated, depending on the evaluation goals and needs. The link emulator was implemented using a Dummynet-enabled [Carbone and Rizzo, 2010] transparent bridge together with the KauNet extension [Hall et al., 2012]. By using this kind of deterministic network emulation tool, the proposed framework provides a fully configurable environment, enabling the study of several network conditions that require a minor configuration. This solution does not require changes in the other components, since it acts as a transparent bridge between the “Video Server” and the access network.

Therefore, it is possible to emulate scenarios with controlled packet loss or delay where the environment is stable, and the experiments can be repeated within the same conditions. For example, the following network-related parameters can be configured through KauNeT/Dummynet:

- ▶ *Bandwidth*: Makes it possible to limit the bandwidth used, by adopting both static and dynamic approaches;
- ▶ *Packet Loss*: Allows a deterministic packet loss percentage or configuration;
- ▶ *Bit-Error*: The Same as the “Packet Loss” but at a bit level for packet transmission, allowing errors to be introduced into specific bits;
- ▶ *Delay*: Changes in end-to-end delay, for instance, by introducing extra delays or using a certain delay pattern depending on the number or type of packets;
- ▶ *Trigger patterns*: Allows emulation of cross-layer mechanisms by reacting to certain applications or triggers at a lower level.

3.2.3 Measurement Parameters

The proposed framework can report information about both video streaming quality and energy consumption.

3.2.3.1 Video Quality Assessment

The video quality can be assessed by both Quality of Service and Quality of Experience metrics. QoS related metrics allow the network behavior to be understood through the assessment of packet loss, end-to-end delay, delay variation and rate information.

The report concerning QoS related metrics is always given by the tool used to perform video traffic generation (Section 3.2.1.1), while Quality of Experience can be assessed by using any external tool that is able to compare two raw movies. The “*Video Quality Assessment*” procedure requires raw format of both original video file and video file reconstructed using network information, as illustrated in Figure 3.1.

Even though some video traffic generation tools can also be used to obtain QoE-related information, the available QoE metrics are usually limited. Therefore, this framework enables different tools to be employed in the video Quality of Experience assessment, with minor modifications required (e.g., syntax issues) in the projected *scripts*.

As an example, Evalvid can give information like Peak Signal Noise to Ratio (PSNR), Mean Option Score (MOS) or Structural Similarity Index (SSIM), but not Video Quality Metric (VQM). By using the same input information, the MSU Video Quality Measurement Tool [MSU Graphics & Media Lab (Video Group), 2015] can provide around twenty QoE-related metrics, including all those mentioned previously. The MSU Video Quality Measurement Tool is a software designed exclusively to perform objective video assessment.

3.2.3.2 Energy Consumption

Energy is assessed by measuring both power and energy consumption for the reception of a video. Moreover, power can be analyzed as a function of time, so that the video characteristics can be correlated with the power consumption. The energy consumption for a desired period (which is different from the total video playing time) can also be obtained.

Equation 3.1 depicts the energy consumption, where “Time” represents the time needed to perform the video reception and “Power” is defined as work done at the rate

3. An Evaluation Framework to assess Video Transmission Energy Consumption and Quality

of one Joule per second. The relationship between the “Power” and both “Voltage” and “Current” is illustrated in Equation 3.2.

$$Energy(Joule) = Power(watts) \times Time(seconds) \quad (3.1)$$

$$Power(watts) = Voltage(volt) \times Current(ampere) \quad (3.2)$$

All the units showed in the equations are the ones defined by the International System of Units.

When employing the EViTEQ framework energy monitor facility the energy consumption assessment can be performed by collecting only the current values, as the voltage is stable (see Section 3.2.1.2). Using these values it is possible to obtain the total energy consumption by applying Equations 3.2 and 3.1.

3.3 Evaluation and Discussion

This section describes the results of the combined assessment of video Quality of Experience and network energy consumption using the developed framework. Subsection 3.3.1 outlines the assessment procedure, including the objectives and video sequences used, while Subsection 3.3.2 discusses the main results obtained when employing the proposed framework in a real environment testbed.

3.3.1 Assessment Procedure

The experimental evaluation has two goals. First, to assess the impact of video categories and network conditions on QoE and energy consumption. Second, to demonstrate the capability of the proposed framework to achieve accurate results measuring both video quality and energy consumption. The assessment procedure is outlined in detail in the following sections.

3.3.1.1 Video Sequences

The video sequences used were taken from the SVT High Definition Multi-Format Test Set [Keimel et al., 2012]. Four distinct sequences were selected to carry out this evaluation, as illustrated in Figure 3.3. The following movies - “*CrowdRun*”, “*InToTree*”, “*Old-TownCross*” and “*ParkJoy*” - were selected for this study since they represent a good set of varied “coding complexity” movies. “*CrowdRun*” and “*ParkJoy*” sequences have a

high level of “coding complexity”, while both “*InToTree*”, “*OldTownCross*” are considered to have lower “coding complexity” [Deng et al., 2011].



Figure 3.3: Selected video sequences: a) CrowdRun, b) InToTree, c) OldTownCross and d) ParkJoy

All sequences have a resolution of 1920x1080 pixels, a frame rate of 25 frames per second, and contain 250 frames. The videos used in this evaluation were compressed by H.264/MPEG-4 AVC codec. All the video-related operations were performed using *ffmpeg* software [Tomar, 2006]. Additionally, all the movies were codified, using a GOP of 30 frames with 25 Frames Per Second (FPS).

Several examples of video assessment in the literature attempt to study video streaming performance by only using distinct *bitrates*, which does not guarantee a consistent degree of quality assessment since the video quality and “coding complexity” will have a strong impact on the process. Hence, this study seeks to control the video quality by using the Constant Rate Factor (CRF) with the aim of achieving a certain quality for the complete sequence, without directly controlling the file size. This has been undertaken by selecting three different CRFs (27, 36 and 45), which were mapped into three different video qualities, *High*, *Medium* and *Low*, respectively. The CRF scale ranges from 0 to 51, where 0 is lossless, 23 is the default compression and 51 represents the worst possible quality. Table 3.1 shows the most significant parameters for each compressed sequence.

3.3.1.2 Network Conditions and Scenarios

The network configuration entity, introduced in Section 3.2.2, allows distinct network configurations to be designed that make use of single parameters (i.e. they only introduce extra delay) or combined parameters (e.g. random packet loss and extra delay).

In this assessment, three different scenarios and configurations were selected. First of all, a scenario without restrictions was defined. This configuration allows the study of a scenario with nearly ideal network conditions, where all the traffic is routed through the Kaunet/Dummynet bridge without changes.

The other two scenarios were defined with the aim of studying the video stream-

3. An Evaluation Framework to assess Video Transmission Energy Consumption and Quality

Table 3.1: Parameters of compressed video sequences

Name: Sequence and Quality	CRF	Average Bitrate	Ref. PSNR	Ref. SSIM	Ref. VQM
<i>CrowdRun-Low</i>	45	1285 kb/s	22.75	0.56	6.81
<i>InToTree-Low</i>	45	491 kb/s	27.54	0.60	4.43
<i>OldTownCross-Low</i>	45	449 kb/s	27.88	0.71	3.83
<i>ParkJoy-Low</i>	45	1044 kb/s	21.42	0.52	7.53
<i>CrowdRun-Medium</i>	36	4149 kb/s	26.71	0.74	4.13
<i>InToTree-Medium</i>	36	1510 kb/s	30.81	0.73	2.92
<i>OldTownCross-Medium</i>	36	1078 kb/s	32.12	0.82	2.33
<i>ParkJoy-Medium</i>	36	4224 kb/s	25.17	0.74	4.66
<i>CrowdRun-High</i>	27	13721 kb/s	31.97	0.89	2.25
<i>InToTree-High</i>	27	6581 kb/s	34.47	0.85	1.83
<i>OldTownCross-High</i>	27	3689 kb/s	35.01	0.87	1.58
<i>ParkJoy-High</i>	27	17067 kb/s	30.86	0.90	2.46

ing perceived quality and energy consumption in scenarios where the network is, for some reason, experiencing delay or packet loss. Extra delay was introduced in the network by means of the defined network configuration entity. The purpose of this was to emulate the delay in the transmission, which can be caused by the communication distance or even by MAC layer retransmissions if there is a bad signal-to-noise ratio. The configuration includes scenarios with 20ms, 40ms, 80ms, 160ms and 320ms extra delay.

A similar process was carried out to emulate scenarios with packet loss, where various packet loss probabilities were introduced in the network (0.5%, 1%, 2% and 4%). The defined scenarios for the empirical evaluation are summarized in Table 3.2.

3.3.1.3 Testbed

This subsection outlines the University of Coimbra IEEE 802.11 testbed, illustrated in Figure 3.4. The IEEE 802.11 access network is composed of a IEEE 802.11n router (Cisco Linksys E4200) and USB network interface (Cisco Linksys AE1000) at the end system, both operating in the 2.4GHz band.

The testbed was configured to support the proposed framework for video quality and energy consumption (Figure 3.1). The system clocks of the end-hosts were synchronized with an open-source implementation of the IEEE 1588 Precision Time Protocol (PTP), the PTPd [Correl, 2015], to measure one-way end-to-end delay. PTPd provides synchronization accuracy in the magnitude of sub-milliseconds, in the or-

Table 3.2: Configured scenarios for the assessment

Scenario Name	Parameters	Value	Expected behavior
No Restrictions	-	-	-
Delay-20	Delay	20 ms	Extra delay of 20ms in all packets
Delay-40	Delay	40 ms	Extra delay of 40ms in all packets
Delay-80	Delay	80 ms	Extra delay of 80ms in all packets
Delay-160	Delay	160 ms	Extra delay of 160ms in all packets
Delay-320	Delay	320 ms	Extra delay of 320ms in all packets
PL-05	Packet Loss	0.5 %	0.5% of all packets are lost randomly
PL-1	Packet Loss	1 %	1% of all packets are lost randomly
PL-2	Packet Loss	2 %	2% of all packets are lost randomly
PL-4	Packet Loss	4 %	4% of all packets are lost randomly

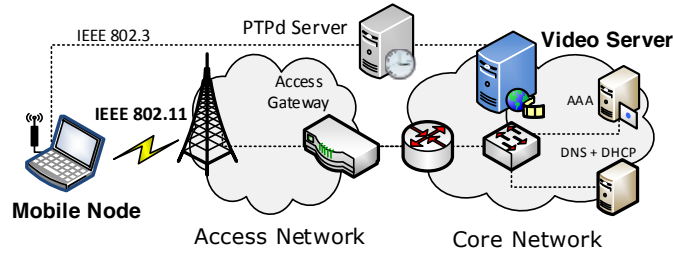

Figure 3.4: IEEE 802.11 testbed architecture

der of $10 \mu s$ [Correll and Barendt, 2006]. All the hosts use a dedicated network card for the exchange of PTP messages to ensure that the synchronization traffic does not introduce overhead into the wireless link.

The “*Mobile Node*” was configured in an Asus EEE 1001PX-H netbook equipment, running Ubuntu Linux kernel version 2.6.32-21-generic. The netbook includes the USB stick and all the energy-related measurement facilities, as was discussed in the description of the framework. The “*Video Server*” machine, which is located in the core network, is a HP ProLiant DL320 G5p server running Debian Linux kernel version 2.6.32-5-amd64. The Dummynet/Kaunet bridge runs over FreeBSD 7.4, since this is the system recommended for it.

All the video streaming traffic referred to in the rest of the chapter is generated by the “*Video Server*” machine in the core network using Evalvid and received by the “*Mobile Node*” in each scenario. The transmissions were performed using the Real-Time Protocol (RTP), but the framework is fully independent of the employed transmission protocol.

All the results analyzed in the following sections are measured in accordance with

3. An Evaluation Framework to assess Video Transmission Energy Consumption and Quality

the proposed procedure, and include 30 runs for each test setup with a confidence interval of 95%. The energy consumption was calculated by measuring the electric power consumption using a rate of 50k samples per second.

3.3.1.4 Metrics

The proposed assessment procedure uses different metrics to evaluate both video quality and energy consumption.

As well as the metrics used for analyzing the typical packet loss, end-to-end delay and frame loss, two distinct video quality metrics were also employed. The video Quality of Experience metrics that were selected were the Structural Similarity and the Video Quality Metric.

Both QoE metrics employed in this study were obtained using the MSU Video Quality Measurement Tool, since Evalvid is not able to report the Video Quality Metric. Therefore, in this setup, Evalvid was used only to reconstruct the video and to assess the network-related metrics previously described.

The energy efficiency of video streaming was assessed by calculating the total energy consumption needed to transmit the complete video in the network, as already discussed in Section 3.2.3.2.

3.3.2 Results

This section discusses the results obtained by employing the assessment procedure described earlier. First, the IEEE 802.11 scenario without restrictions is outlined in Subsection 3.3.2.1, followed by the study of scenarios with extra delay introduced via the network configuration in Subsection 3.3.2.2. Finally, Subsection 3.3.2.3 shows the results for the scenarios with packet loss.

3.3.2.1 IEEE 802.11 Scenario without Restrictions

This section discusses the results obtained from the video quality and energy consumption assessment performed in the IEEE 802.11 testbed without using the Dummynet bridge / link emulator (i.e. it was disabled).

The Structural Similarity (SSIM) values for all the tested sequences/qualities (see Table 3.1) are depicted in Figure 3.5. The x-axis shows the video quality, while the SSIM metric is represented on the y-axis.

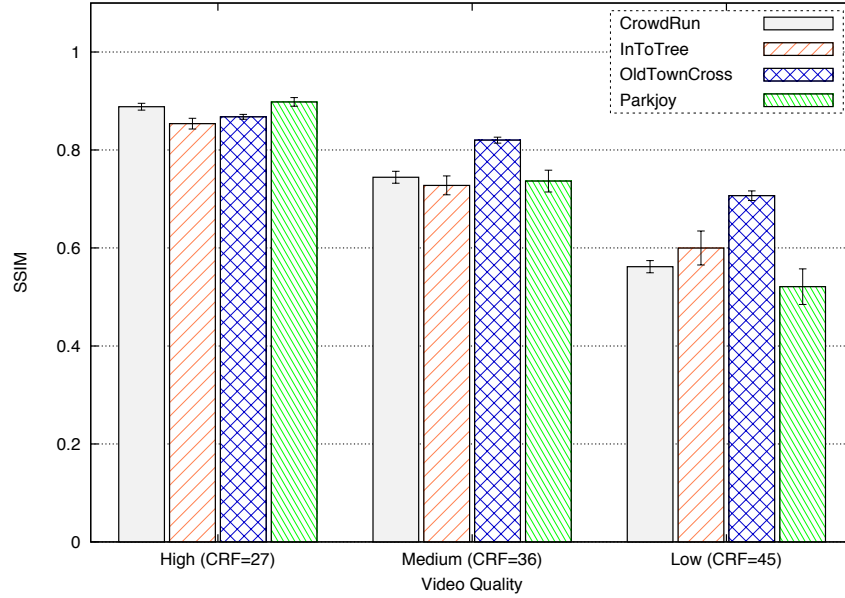

Figure 3.5: IEEE 802.11 native scenario: Structural Similarity (SSIM)

The results for “*High Quality*” sequences always show an $SSIM \geq 0.85$, which means that the similarity is high when compared with the original video. Although the network conditions in the IEEE 802.11 testbed that was used, are very good, the SSIM values were not at the maximum (i.e. $SSIM=1$). The reason for this is that the maximum possible SSIM for each sequence is directly related to the employed video data compression. The SSIM values illustrate their similarity compared with the corresponding *lossless* movies. This means that, when analyzing the results, the maximum possible SSIM values for each video must be those shown in Table 3.1. The obtained values for a 95% confidence interval, represented by the vertical lines over each bar, show the accuracy of the empirical framework proposed, where the uncertainty was always below 3%.

The relationship between the defined quality levels (*High*, *Medium* and *Low*) and the respective SSIM is clear. However, the type of movie selected to be used in this study has also had an impact on the quality assessment. The “*CrowdRun*” and “*ParkJoy*” sequences have a hard coding complexity and this can be noticed in the quality perceived by the end-user. For instance, when the “*CrowdRun-Low*” sequence is used, the decline in quality, in terms of SSIM, when compared with the “*CrowdRun-High*” is around 37%, while the decline for the equivalent qualities using an “easy coding video”, (the “*OldTownCross*”), is only around 18%.

3. An Evaluation Framework to assess Video Transmission Energy Consumption and Quality

The Video Quality Metric (VQM) was also employed to study the Quality of Experience perceived by the end-user when receiving each of the sequences with the different qualities. The VQM results are depicted in Figure 3.6. The x-axis shows the video quality and the VQM is plotted on the y-axis. In the VQM metric, higher values represent a worse quality.

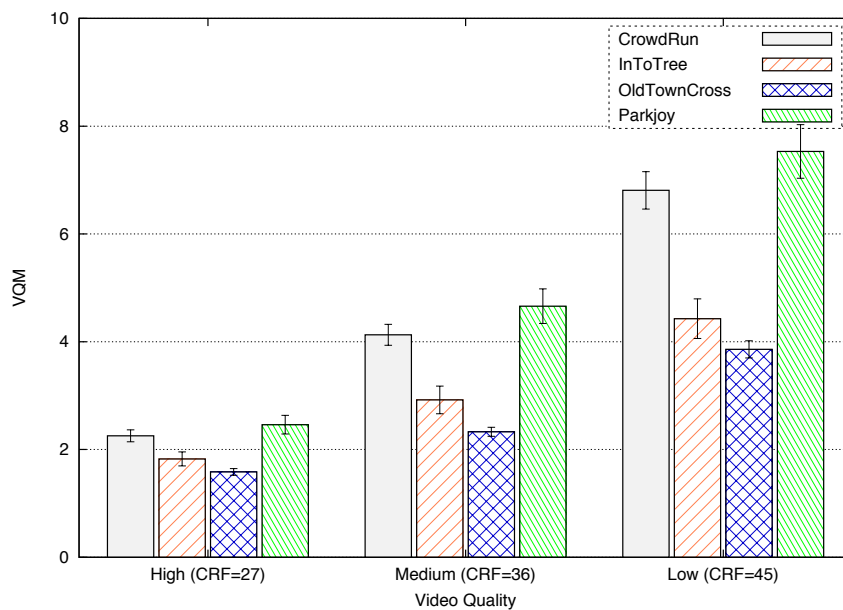

Figure 3.6: IEEE 802.11 native scenario: VQM

The VQM results highlight the gap between “High” and “Low” quality in the complex videos (i.e., “CrowdRun” and “ParkJoy”). For instance, the “ParkJoy-Low” sequence has VQM=2.46, while the “ParkJoy-Medium” and “ParkJoy-High” have VQM=4.66 and VQM=7.53 respectively. The results for the “InToTree” sequence range from VQM=1.83 for “Low” quality sequence and VQM=4.43 for the “High”. This means that the “InToTree-Low” movie has a slightly better quality than “Parkjoy-Medium”.

With regard to quality metrics and making an absolute comparison between the videos, there are some differences between the performances of SSIM and VQM. Table 3.3 shows the ranking of each video with both the SSIM and VQM metrics.

It can be observed that VQM always keeps the same ranking for each tested sequence, regardless of the employed compression quality (i.e. distinct Constant Rate Factor). In the case of SSIM, it only follows the same pattern in the “High” quality sequences. Although this study does not seek to compare the performance of the video quality metrics, this distinct behavior between the two metrics should be high-

Table 3.3: Quality ranking of sequences when employing SSIM and VQM metrics

Quality Ranking	Structural Similarity(SSIM)		
	High Quality	Medium Quality	Low Quality
1 st	ParkJoy	OldTownCross	OldTownCross
2 nd	CrowdRun	CrowdRun	InToThree
3 rd	OldTownCross	ParkJoy	CrowdRun
4 th	InToThree	InToThree	ParkJoy

Quality Ranking	Video Quality Metric (VQM)		
	High Quality	Medium Quality	Low Quality
1 st	ParkJoy	ParkJoy	ParkJoy
2 nd	CrowdRun	CrowdRun	CrowdRun
3 rd	OldTownCross	OldTownCross	OldTownCross
4 th	InToThree	InToThree	InToThree

lighted, since the metric selection plays an important role in the assessment of video streaming Quality of Experience. Such behavior might be explained by the metrics definition. The SSIM measures the similarity between each two images in the video, while VQM also includes valid regional estimators and analysis of spatial and temporal alignments.

Apart from the Quality of Experience perceived by the end-user, the energy consumption is also beginning to become an important assessment parameter of experience. In fact, both video quality and energy consumption affect end-user satisfaction, since the battery lifetime can be more important than the streaming quality.

By employing the proposed testing procedure, it was possible to measure the energy consumed. Figure 3.7 shows the total energy consumed in Joule (y-axis) when receiving each distinct sequence.

Since in this study the IEEE 802.11 interface does not have any enabled power saving mode, which can allow the network interface to enter in a state of lower energy consumption (e.g., *idle mode*) when no communication with the network is required, the energy consumption mainly depends on the video quality. Thus, the energy needed to transmit the “High” quality videos is slightly higher than both “Medium” and “Low” video qualities. However, the difference shown between the two lower qualities is not significant.

The results highlight the need to establish a proper relationship between end-user perceived Quality of Experience and energy spent to receive a video streaming over the network. Moreover, when using cellular network environments, where the traffic

3. An Evaluation Framework to assess Video Transmission Energy Consumption and Quality

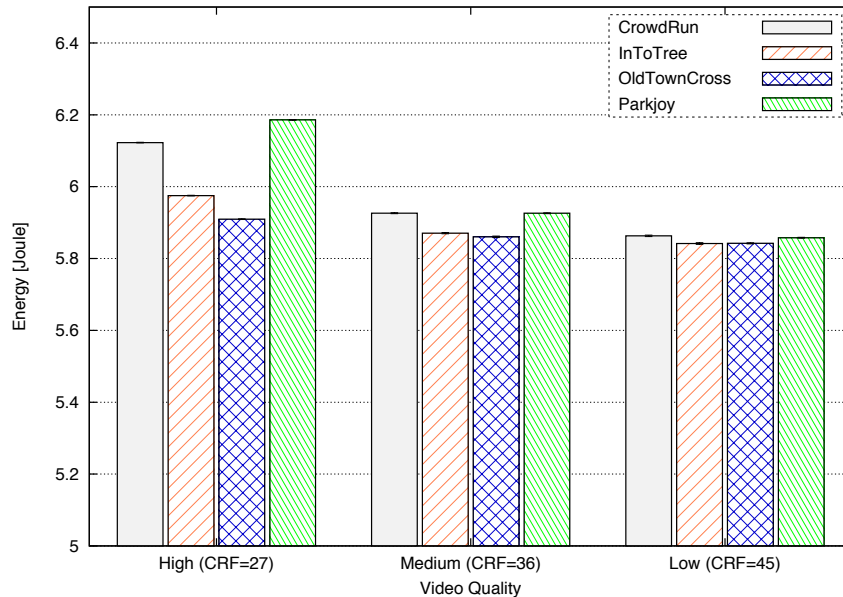

Figure 3.7: IEEE 802.11 native scenario: total energy consumption

costs are usually higher than in IEEE 802.11, the cost/benefit tradeoff between the achieved overall end-user satisfaction and the billing costs should also be taken into account.

3.3.2.2 IEEE 802.11 Scenario with Extra Delay

This subsection examines the results obtained in the scenario where extra delay.

The extra delay configurations encompass four scenarios and use distinct delay values. Figure 3.8 shows the real delay (in milliseconds) measured in the testbed, in accordance with each of the extra delay values that are configured (x-axis). The x-axis also shows the control delay, which is the delay when no restrictions were introduced.

The “*CrownRun*” sequence was selected as an example, since the level of accuracy in the results is similar for all the sequences.

It is clear that, by using the network configuration entity, this study can achieve a good level of accuracy in terms of the extra delay that is introduced. The confidence interval lines that are plotted in each bar, show a greater fluctuation in the higher quality sequence, which can be explained by the superior *bitrate*.

The Quality of Experience that is perceived by the end-user is illustrated in Figure 3.9. The QoE is given by the VQM metric on the y-axis, while the extra delay scenarios for the whole “*CrownRun*” scenario are represented on the x-axis. As well as this, the

3.3 Evaluation and Discussion

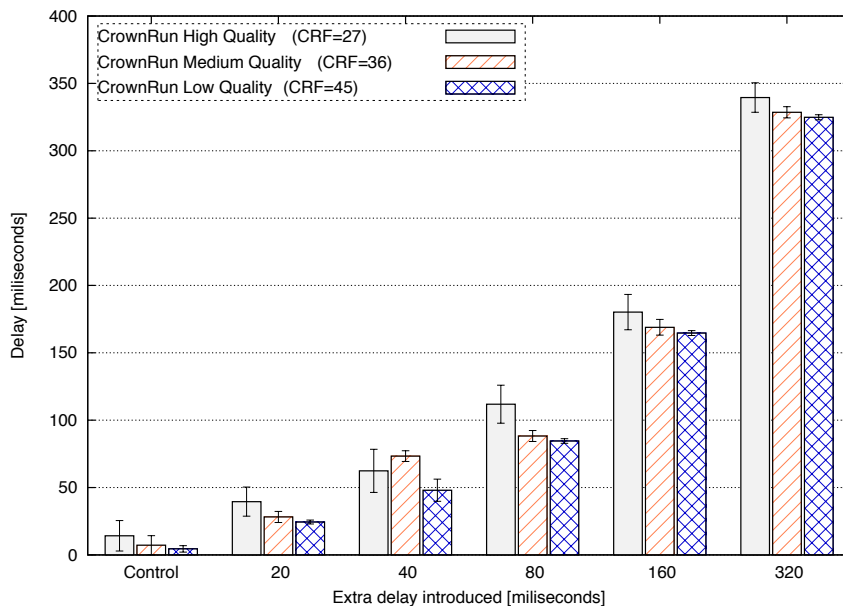

Figure 3.8: Delay for extra delay Crowdrun video sequences

control bars show the values corresponding to the scenario without restrictions.

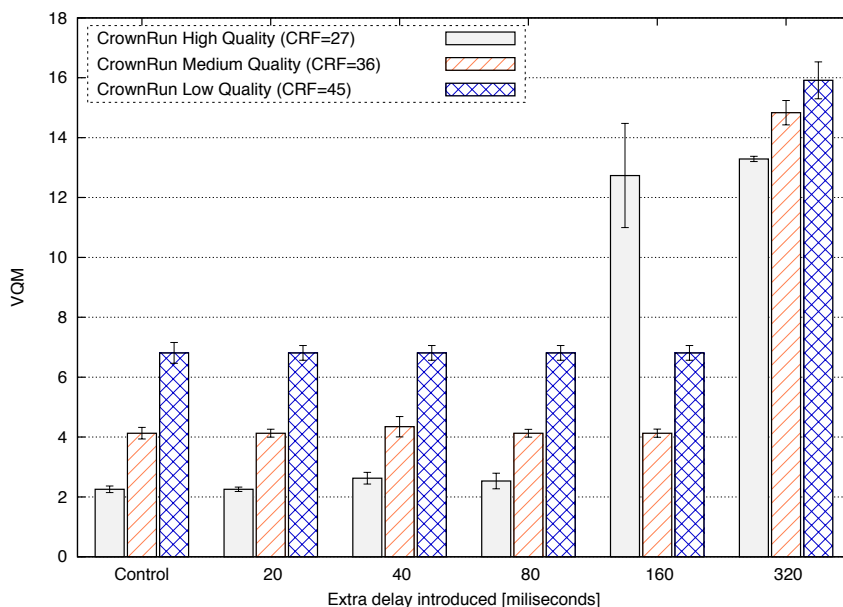

Figure 3.9: VQM for extra delay scenarios of Crowdrun sequences

In all the tests performed, the *playout time* was always defined as 200 ms. The

3. An Evaluation Framework to assess Video Transmission Energy Consumption and Quality

playout time buffer is a parameter used to control the received video file reconstruction, and it allows frame delay to be “converted” into frame loss. The results highlight the importance of this buffer, since it is closely linked to the maximum tolerable delay during the video streaming transmission. As a result, the effects on the Quality of Experience of the extra delay introduced in the first three scenarios is negligible. When the extra delay introduced is equal to 160 ms, there is already quality degradation for the higher quality video. The “High” quality video has an average delay of around 180 ms, but some outlier packets have delays greater than the defined *playout time*, which results in an overall frame loss of around 5.55%. Therefore, in this case, both “Low” and “Medium” quality videos achieve better VQM than the “High” quality sequence. In the scenario with an extra delay of 320 ms, the impact of delay is clearly noticeable in all the sequences.

The same VQM analysis was also conducted for the low complexity movie “*OldTownCross*” and shown in Figure 3.10, where a similar QoE degradation pattern can be observed.

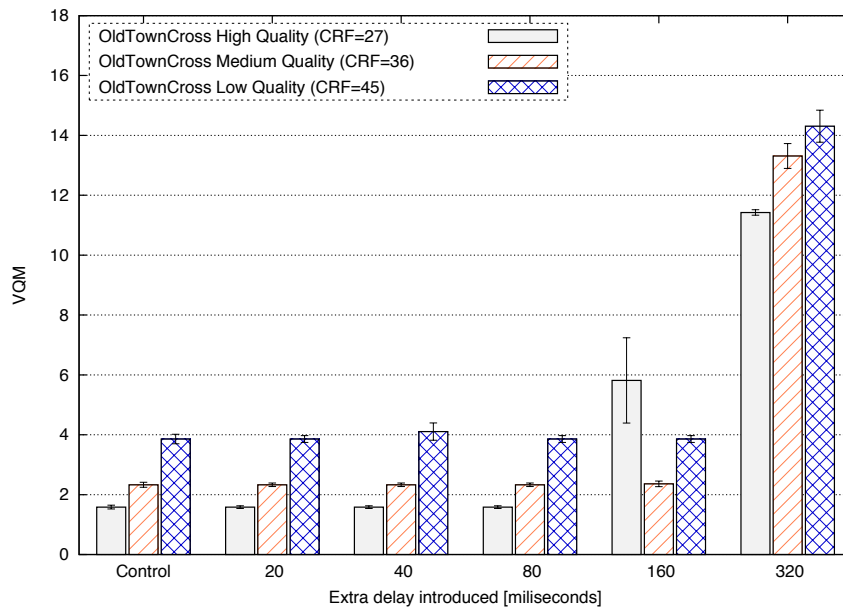

Figure 3.10: VQM for extra delay scenarios of OldTownCross sequences

Although the degradation pattern is identical, the absolute quality of ‘*OldTownCross*’ sequence is higher when compared with “*CrownRun*” for this scenario. However, in the scenario without restriction both have similar absolute quality. This behavior is related with the lower coding complexity of “*OldTownCross*”, since it needs lower

bitrate to be transmitted and, consequently, it is less affected by quality degradation introduced by the extra delay present in the link.

The energy consumption information is not depicted for this scenario, since apart from the extra delay introduced, all the information will be received by the end-users, leading to similar results as the ones presented in previous the section.

3.3.2.3 IEEE 802.11 Scenario with Packet Loss

This subsection examines the scenarios where packet loss is introduced, by using the network configuration tool.

Figure 3.11 shows the real packet loss (y-axis) measured for each of the scenarios with configured packet loss, from 0.5% to 4%, as depicted on the x-axis.

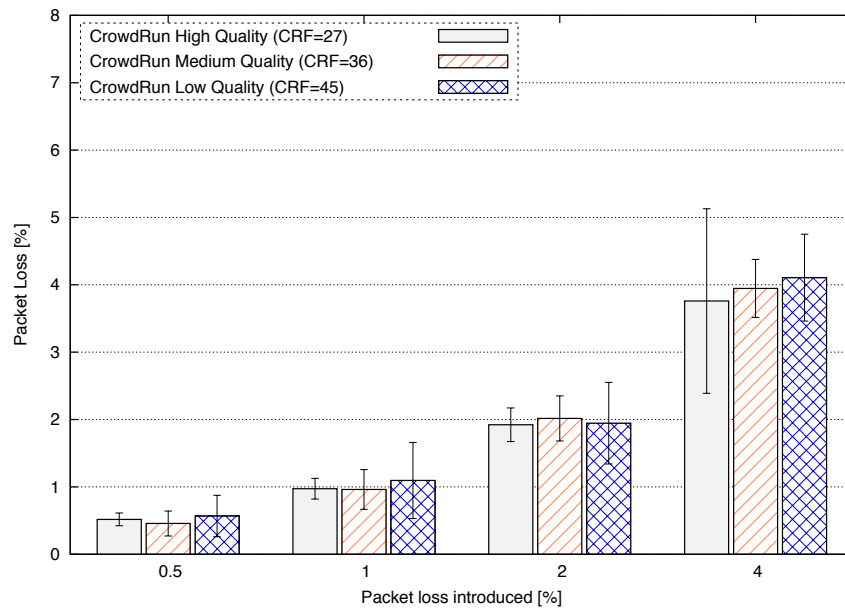

Figure 3.11: Packet loss for Crowdrun scenarios with configured packet loss

The results demonstrate that the relationship between the configured packet loss rate and the real packet loss measured in the tests is aligned. Since the packet loss probability is random, more fluctuations occur in the video frame losses, as depicted in Figure 3.12.

A comparison between the analysis of the frame loss analysis and the packet loss rate, highlights the need to have accurate Quality of Experience metrics to evaluate the perceived end-user quality correctly. The QoE assessment based on the VQM metric is illustrated in Figure 3.13.

3. An Evaluation Framework to assess Video Transmission Energy Consumption and Quality

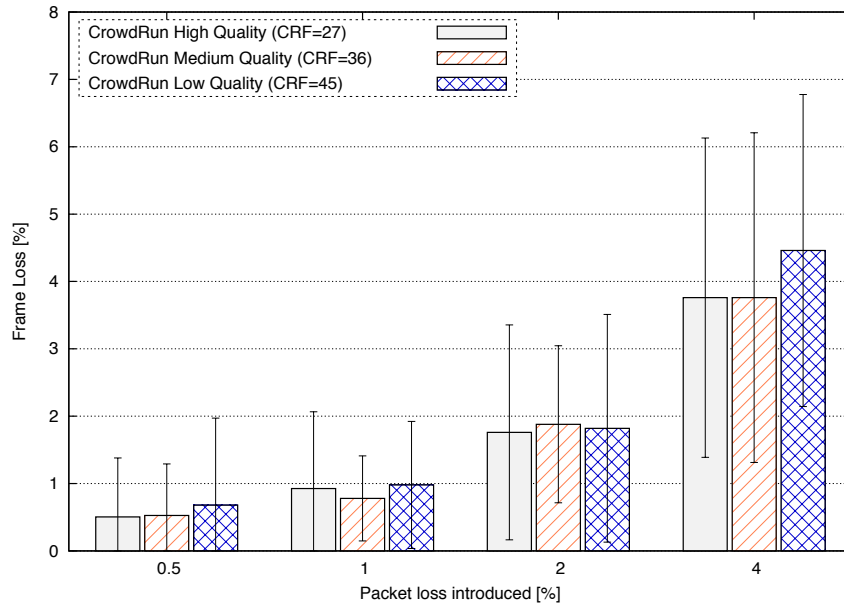

Figure 3.12: Frame loss for CrowdRun scenarios with configured packet loss

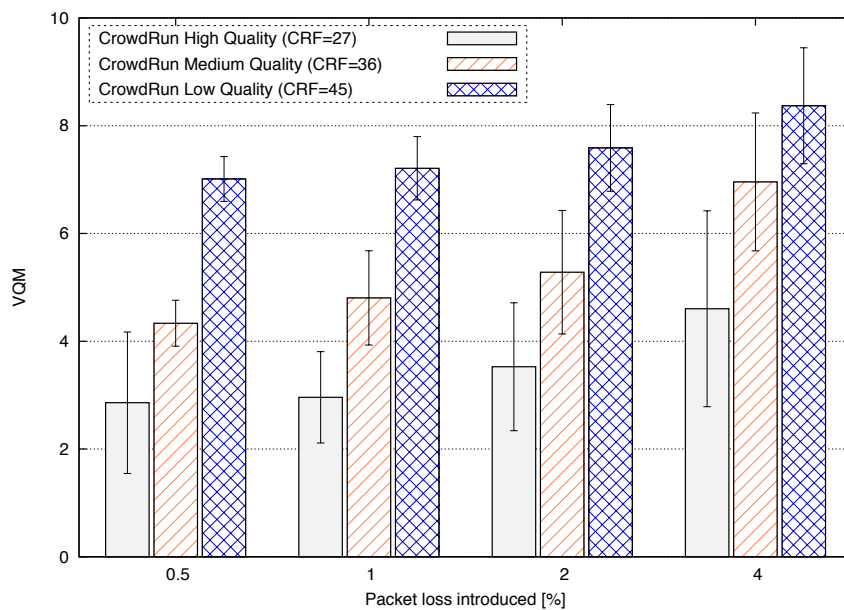

Figure 3.13: VQM for CrowdRun scenarios with configured packet loss

The results depict the direct impact of packet loss on the quality, since quality degradation increases with higher packet losses. However, with lower packet loss rates the quality is not significantly affected, since the codec is able to deal with a

certain amount of packet loss without affecting the quality perceived by the end-user. It can be observed that when “High” quality sequences are transmitted, the impact on the perceived QoE is higher.

The energy consumption is illustrated in Figure 3.14, where the the total amount of energy consumed during the transmission (in Joule) is represented on the y-axis. The energy consumption for the scenarios with a higher packet loss is slightly lower, since there are fewer packets being received by the end-user.

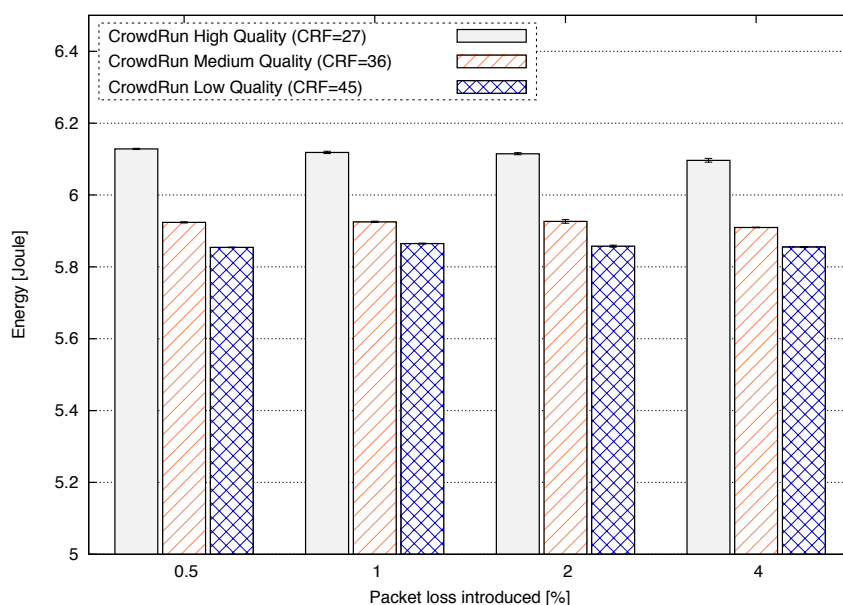

Figure 3.14: Total energy consumption for Crowdrun scenarios with configured packet loss

These results show the importance of accurate mechanisms to control the video quality and energy consumption, since in the presence of packet loss, higher quality videos do not bring any advantage, neither concerning energy consumption nor end-user perceived quality. Additionally, under these conditions, the usage of high demanding videos will contribute to a faster wireless link degradation, as it is increasing the collision probability.

3. An Evaluation Framework to assess Video Transmission Energy Consumption and Quality

3.4 Investigating Energy Consumption in Wireless Access Networks using EViTEQ Framework

Although the EViTEQ framework was designed to encompass the multi-featured video transmission evaluation concerning the end-user perceived quality and the energy consumption, its flexibility allows the usage in distinct scenarios. Therefore, this section describes experimental investigations concerning the energy consumption of wireless access networks employing the EViTEQ framework, using IEEE 802.11 as case study. Nevertheless, as already described in Section 3.2.1.2, this methodology can be employed with any USB network card.

The main objective of this assessment is to show how to perform an empirical energy assessment in a real wireless access network. Additionally, by using the presented energy evaluation methodology within EViTEQ framework, a twofold investigation is performed. First, the impact of wireless states management in the network interface energy consumption is discussed, followed by some insights concerning relationship between application design and its energy demands.

3.4.1 IEEE 802.11 Access Network Testbed and Scenarios

This investigation uses the testbed presented in Section 3.3.1.3. As the energy measurement testbed is fully independent of the employed network interface, it will be possible to use any other USB network interface. Therefore, in addition to the Cisco Linksys AE1000 dual-band (2.4GHz and 5GHz) previously used, this assessment also employs a Linksys TP-LINK WN-721n single-band (2.4GHz).

The results presented in the next subsections were obtained using the energy methodology presented in Section 3.2.1.2, and include 20 runs for each test setup with a confidence interval of 95%. The tests were done in three distinct wireless access scenarios, as depicted in Table 3.4.

Each test performed has a total duration of 80 seconds, whereas the first and the last 10 seconds of the experiment were not considered, in order to avoid the impact of the energy consumed by the User Datagram Protocol (UDP) socket establishment and release procedures. As a result, all the energy results presented only consider the energy consumed during 60 seconds.

3.4 Investigating Energy Consumption in Wireless Access Networks using EVITEQ Framework

Table 3.4: Experimental evaluation scenarios

Name	Description
<i>NetworkCard-A 2.4GHz</i>	Tests performed using in the Linksys TP-LINK WN-721n in the 2.4GHz frequency (the only supported)
<i>NetworkCard-B 2.4GHz</i>	Tests with the Cisco Linksys AE1000 dual-band network card, using the 2.4GHz frequency
<i>NetworkCard-B 5.0GHz</i>	Tests employing the Cisco Linksys AE1000 dual-band, using the 5.0GHz frequency

3.4.2 Energy Consumption of IEEE 802.11 States

This section discusses the impact of each state of the network interface's overall energy consumption. The IEEE 802.11 relevant PHY layer states, which might have impact on the network card energy consumption, are defined as follows:

- ▶ **Disconnected/Init:** network interface is disconnected from the network, i.e. the radio is switched-off;
- ▶ **Idle:** network interface is associated with the access point, but no data is being transferred;
- ▶ **Sleep:** network interface is in a *doze state*. In this state it is not possible to send or receive traffic, but the station remains associated with the network. This state was studied by enabling the IEEE 802.11 Power Save Mode, discussed in Section 2.1.1.4;
- ▶ **Transmitting (TX):** network interface is sending traffic to the network;
- ▶ **Receiving (RX):** network interface is receiving traffic from the network.

The described IEEE 802.11 states transitions diagram is illustrated in Figure 3.15.

Figure 3.16 shows the average power (in milliwatt) used by the three scenarios defined (see Table 3.4) in *DISCONNECTED*, *IDLE* and *SLEEP* states. As energy consumption of *TX* and *RX* states is affected by the traffic configuration and pattern, these states will be further discussed.

When comparing the network cards tested, it can be observed that the *NetworkCard-A 2.4GHz* average power in the *DISCONNECTED* state is higher than both *NetworkCard-B 2.4GHz* and *NetworkCard-B 5.0GHz*. The average power in this state is the same for

3. An Evaluation Framework to assess Video Transmission Energy Consumption and Quality

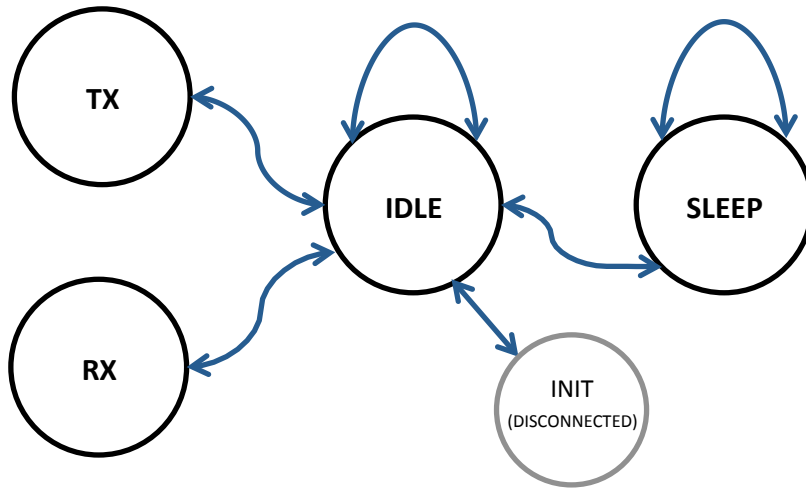

Figure 3.15: Simplified IEEE 802.11 states diagram

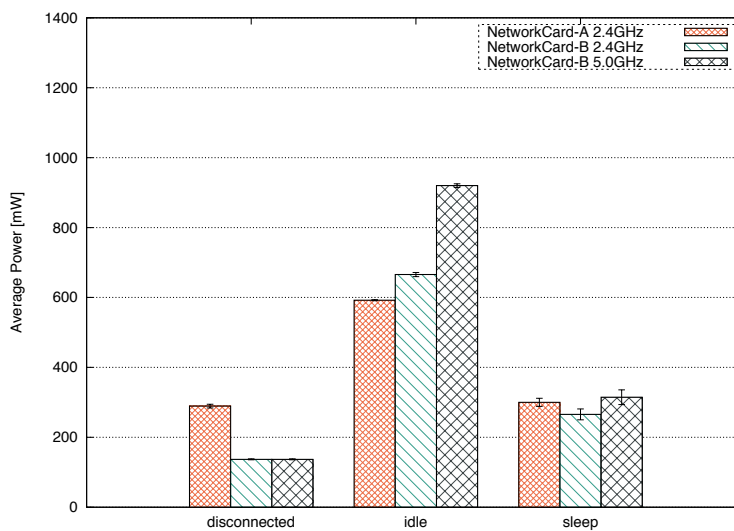

Figure 3.16: Average power in disconnected, idle and sleep states

NetworkCard-B 2.4GHz and *NetworkCard-B 5.0GHz*, since it is the same USB network card.

In *IDLE* state the behavior is slightly different. The *NetworkCard-B 5.0GHz* needs more energy to support this state, when compared with the other two scenarios. While the *NetworkCard-A 2.4GHz* spends roughly twice more energy in *IDLE* state when compared with *DISCONNECTED* state, the *NetworkCard-B 2.4GHz* and *NetworkCard-A 5.0GHz* need, respectively, about 5 and 7 times more energy.

3.4 Investigating Energy Consumption in Wireless Access Networks using EVITEQ Framework

This behavior is mainly related with the network interface internal design. In this particular case study, it might be related with the supported MIMO type, since *NetworkCard-A* only supports 1x1:1 MIMO (1 internal antenna) and *NetworkCard-B* can benefit from the usage of 2x2:2 MIMO (2 internal antennas). Others in literature have shown the MIMO impact on the energy consumption [Li et al., 2011].

Comparing with the *IDLE* state, the *SLEEP* state usage is able to achieve energy savings of around 50%, 60% and 65%, respectively, for *NetworkCard-A* 2.4GHz, *NetworkCard-B* 2.4GHz and *NetworkCard-B* 5.0GHz scenarios.

Although, due to the internal components design, there might be absolute power consumption differences in similar states, one can observe that the power consumption trend among the three depicted states is similar for all the scenarios. This standard energy consumption behavior is extremely relevant, since there are clear energy benefits in keeping the interface as long as possible in the *SLEEP* state.

3.4.3 Power Saving Effectiveness

This subsection has two goals. First, it aims at showing the impact of IEEE 802.11 Power Save Mode usage in a real scenario. Second, it explores power consumption during state transition, introduced in the previous subsection, by establishing a set of actions aiming at forcing the most common transitions.

The transition between states depends on the actual network state at IP level. Therefore, a sequence of actions has been defined to study those transitions. Table 3.5 shows the defined action sequences, including the possible states and the start/end time (in seconds) for each action.

Table 3.5: Action sequence for testing states transitions

#	Possible states	Action	Time	
			start	end
1	<i>DISCONNECTED</i>	wait for 4 seconds	0	0
2	<i>IDLE, TX, RX</i>	connect to the network	4	*
3	<i>IDLE, SLEEP</i>	wait for 10 seconds	4	14
4	<i>TX, RX</i>	ping "Server" during 10 seconds	14	24
5	<i>IDLE, SLEEP</i>	wait for 5 seconds	24	29
6	<i>IDLE, TX, RX</i>	disconnect from the network	29	*
7	<i>DISCONNECTED</i>	-	29	35

* Action includes connecting or disconnecting times, which might be slightly variable.

Figure 3.17 depicts the power (in milliwatt) over time (seconds) for the *NetworkCard-*

3. An Evaluation Framework to assess Video Transmission Energy Consumption and Quality

A 2.4GHz scenario, with the IEEE 802.11 Power Save Mode disabled, during the execution of the previous presented sequence. As *NetworkCard-B 2.4GHz* and *NetworkCard-B 5.0GHz* scenarios have similar behavior, only this scenario will be illustrated. To allow enough precision to depict all the small power fluctuations, this study was performed with a rate of 50.000 samples per second. However, due to the very small power fluctuations captured, the usage of a smoothing technique to depict the values was required. As a result, the power values presented in the following figures are using a moving average of 1000 samples.

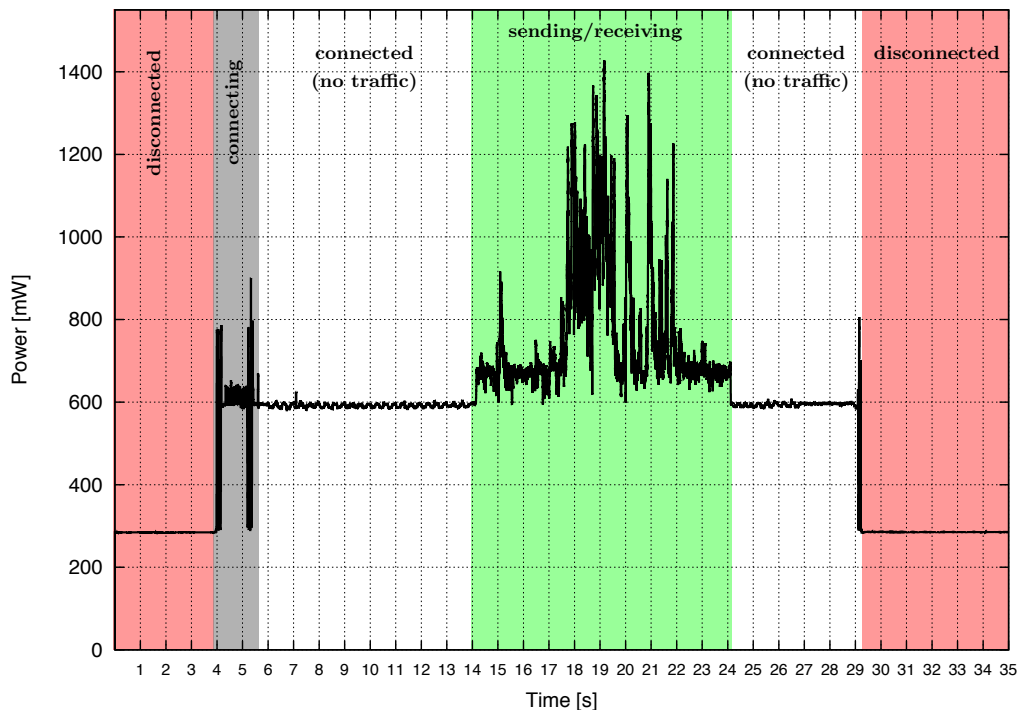

Figure 3.17: *NetworkCard-A 2.4GHz* states transition with power saving disabled

The relationship between the network card interface state and the power consumption is clearly visible. When connecting to the network ($time = 4s$, from now on $t=time$) the power consumption has some fluctuations, mainly because there is information being sent and received from the network. The power consumption becomes stable since no traffic has to be sent or received ($t \geq 5.5s$ and $t \leq 14s$). During this period, the network card is in the *IDLE* state. Since power saving mode is disabled in this scenario, it is not possible to change to the *SLEEP* state.

The power cost of sending and receiving IP traffic ($t \geq 14s$ and $t \leq 24s$) is evidently outlined. Here, the power fluctuations are bigger since the usage of the Internet Con-

3.4 Investigating Energy Consumption in Wireless Access Networks using EViTEQ Framework

trol Message Protocol (ICMP) (using the *ping* tool) enables bidirectional traffic in the channel, and several state transitions turn up in short time intervals.

When the traffic transmission ends ($t = 24s$) the network card backs into *IDLE* state, until it disconnects again from the network after 5 seconds ($t = 29s$).

Figure 3.18 also shows the power (in milliwatt) over time (seconds) for the same sequence and scenario (*NetworkCard-A 2.4GHz*), but with the IEEE 802.11 Power Save Mode enabled.

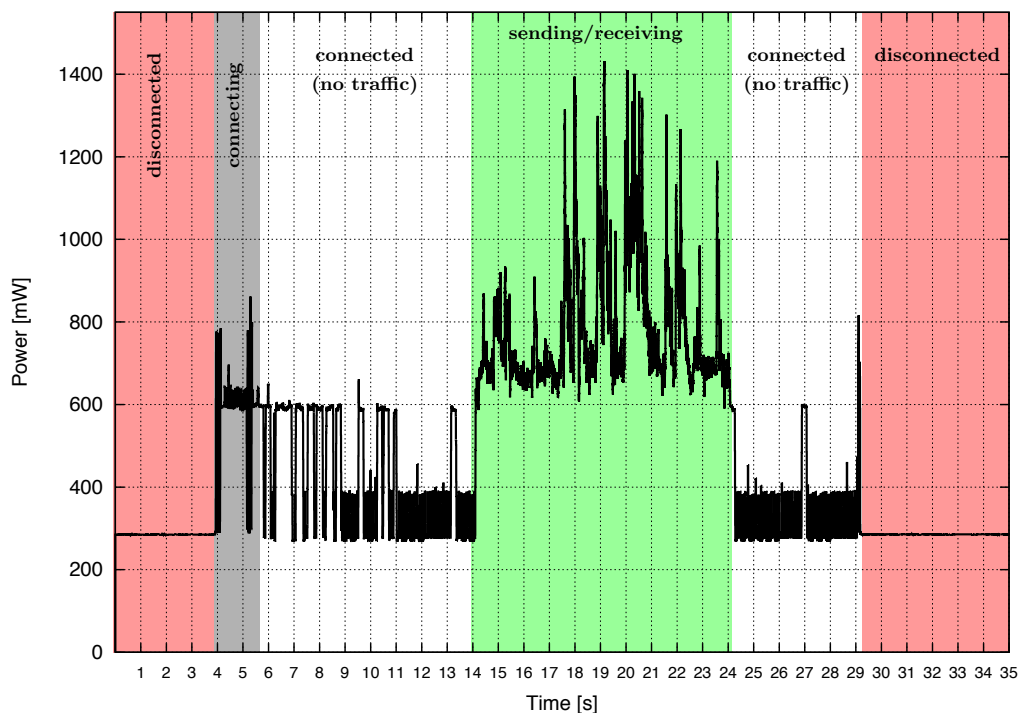

Figure 3.18: *NetworkCard-A 2.4GHz* states transition with power saving enabled

The power consumption behavior is very similar to the one showed in the case where power saving mode is disabled, unless when there is no IP traffic to be sent or received. In this case, the system implementation of IEEE 802.11 Power Save Mode allows the network interface to change the state from *IDLE* to *SLEEP*. Such state changes have a direct impact in power consumption, as depicted in the lower power consumed in both ($t \geq 5.5s$ and $t \leq 14s$) and ($t \geq 24s$ and $t \leq 29s$) intervals.

Even though this representation gives a good overview of the power consumption behavior over time, it is not able to show the fast power fluctuations captured by the used high precision measurement technique. Therefore, it is important to look in the available data with more detail.

3. An Evaluation Framework to assess Video Transmission Energy Consumption and Quality

Figure 3.19 zooms four key actions of the data depicted in Figure 3.18, namely the network connection, the starting of data transmission/reception, the ending of transmission/reception, and the disconnection from the network.

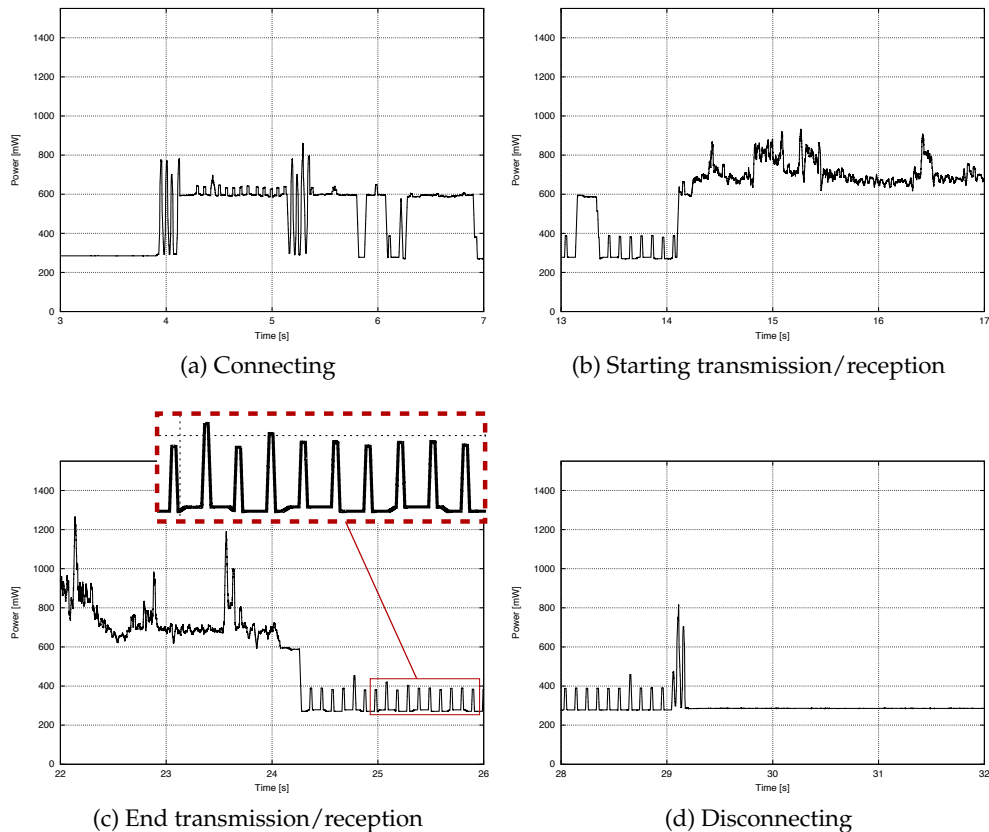

Figure 3.19: *NetworkCard-A 2.4GHz* states transition with power saving enabled

Figure 3.19a depicts the connecting phase, starting in ($t = 4s$). The higher power needed by the network interface to enter and setup the wireless network can be observed. The power consumption increasing of almost 2 times when changing from *SLEEP* to *RX* and/or *TX* state is illustrated in Figure 3.19b. Figure 3.19c shows the end of transmission/reception and illustrates power consumption reduction when IP transmission is finished ($t = 24s$).

Unlike in the *DISCONNECTED* state, when a network interface is in the *SLEEP* state, power fluctuations occur regularly. The regular power fluctuations in *SLEEP* state are caused by the IEEE 802.11 Power Save Mode protocol design (see Section 2.1.1.4). When operating in PSM, the device needs to regularly wake up for receiving

3.4 Investigating Energy Consumption in Wireless Access Networks using EVITEQ Framework

the *Beacon Frames*, which allow the device to be informed of pending data at the Access Point. Such fact produces the power consumption behavior depicted in Figure 3.19c zoom box (red dashed). This zoom box in the sub-figure represents 1 second of duration, and 10 power peaks related with *Beacon Frames* reception can be observed. As the beacon interval in the used Access Point is configured to 100 ms, there will be 10 beacons to be received each second, as depicted.

Figure 3.19d illustrates the network disconnecting phase, starting in ($t = 29s$). The higher power consumption requested upon disconnecting is mainly related with the extra power needed to change to such state, but also to send disconnecting information to the network (e.g., releasing IP address). Again, in the ($t \geq 26s$ and $t \leq 27s$) interval, the *Beacon Frames* reception impact on power consumption in the *SLEEP* state can be perceived.

The possibility to investigate the states' energy consumption with this detail creates a good asset to employ this methodology in the validation of novel energy-aware protocols or applications.

3.4.4 Packet Size Impact

This subsection investigates the packet size impact on the energy consumption. The tests were done employing Constant Bit Rate (CBR) with a fixed sending of 100 packets per second. As explained before, each test has a total duration of 80 seconds, but the first and the last 10 seconds of each experiment were not considered aiming to avoid the impact of upper layer protocol establishment and release procedures in the energy consumption.

Figure 3.20 shows the energy consumption in Joule (y-axis) needed to transfer 6000 packets (i.e., 100 packet per seconds during 60 seconds). The studied packet sizes range from 64 byte to 1400 byte (value near the Maximum Transmission Unit (MTU) for Ethernet), as depicted on the x-axis. Additionally, each scenario was also tested independently in *RX* and *TX* states.

The obtained results for *NetworkCard-A 2.4GHz* and *NetworkCard-B 2.4GHz* scenarios show a non negligible energy consumption difference between the energy needed to transfer the same amount of information in the *TX* and the *RX* states. Nonetheless, the same relationship can not be verified for the *NetworkCard-B 5.0GHz* case. In this later scenario, the energy consumption to send and receive the total 6000 packets is similar in the *TX* and *RX* states. Yet, by analyzing the error bars in this scenario, it is possible to notice a higher uncertainty in the *NetworkCard-B 5.0GHz* scenario when

3. An Evaluation Framework to assess Video Transmission Energy Consumption and Quality

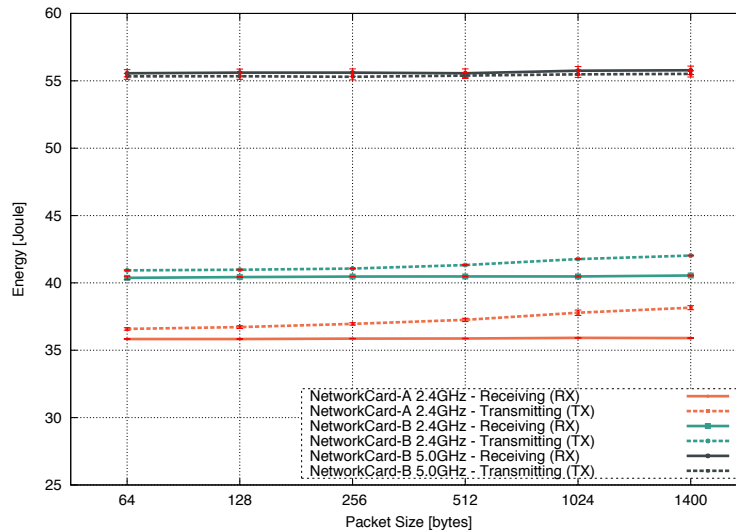

Figure 3.20: Energy consumption with distinct packet sizes

compared with the others.

Apart from the performance comparison between the distinct network cards, it is also important to assess the impact of packet size in the energy consumption. Such study is commonly performed by analyzing the energy cost per bit transmitted [EARTH, 2012].

Figure 3.21 depicts average energy cost per bit transmitted/received in millijoule (y-axis) for the tested packet sizes using the *NetworkCard-A 2.4GHz* scenario. Again, as the other scenarios have similar related behavior only this one will be depicted.

The cost of transmitting a byte using small packets (e.g. 64 byte packet size) is clearly higher than transmitting packets near the Maximum Transmission Unit (MTU) size. For instance, in the depicted *NetworkCard-A 2.4GHz* scenario, each bit received when using 64 byte packet size has a cost of 12.19 mJ, while using a 128 byte packet size the cost is roughly half (i.e., 6.12 mJ). Moreover, using packets with 1400 byte, the cost of each byte received is only 0.58 mJ. As expected, according to the values presented in Figure 3.20, the energy consumption per bit when transmitting (TX) and receiving (RX) the data is very low (around 0.04 mJ).

By analyzing these results, the importance of the packet size on the energy consumption becomes clear. For instance, the typical small packet size applications like Voice Over IP (VoIP) are potential energy demanding applications, whereas the bulk data transfer applications should be more energy efficient, since typically larger packets are used. Concerning the importance of the aggregation others in literature, e.g.,

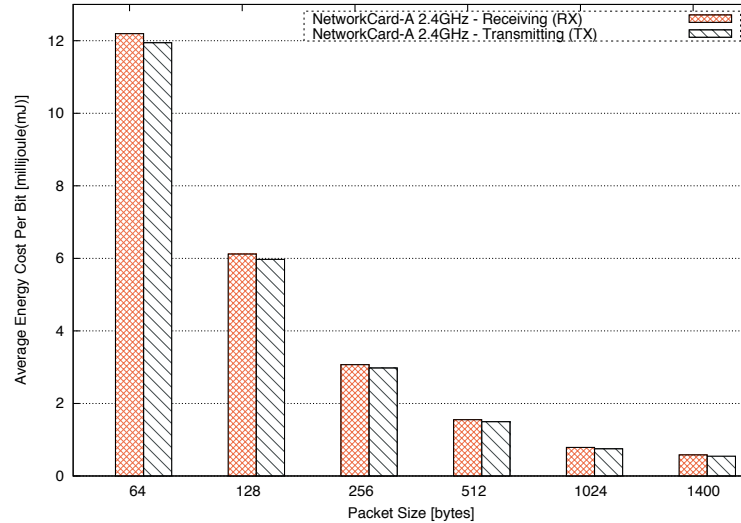

Figure 3.21: Energy consumption with distinct packet sizes

[Shah et al., 2014], have studied the benefits of employing aggregation techniques.

3.5 Summary

This chapter has proposed EViTEQ, an integrated framework to assess video energy consumption and quality in heterogeneous networks with variable conditions. Extensive experimentations have shown the importance of video sequences and compression parameters in the performance of video streaming, especially when assessing Quality of Experience metrics. With regard to energy consumption, the experimental results showed that the energy costs of transmitting video sequences are closely related with the video quality. The systematic characterization of energy consumption profiles within real systems can be used for multiple purposes. On one hand, for the development of optimized mechanisms that dynamically adapt video coding and transmission parameters, taking into account the desired quality level and available energy or expected battery lifetime. On the other hand, to develop enhanced energy saving mechanisms that use information about the video characteristics and perceived quality of experience to perform aggregation or dynamic adaptation of sleep periods. The experimental data about Quality of Experience and energy consumption can also be used to create or improve simulation models, which fills an important gap in the literature.

Additionally, the EViTEQ framework was employed to perform an extensive in-

3. An Evaluation Framework to assess Video Transmission Energy Consumption and Quality

investigation concerning the energy consumption in wireless networks. Apart from demonstrated the flexibility and versatility of the proposed framework, the experimental investigation conducted in the IEEE 802.11 testbed highlighted the energy benefits of using power saving modes correctly. By observing the attained results, it was possible to conclude that the correct management of the wireless states might lead to energy savings up to 65%. The gathered data also depicted the application level impact on the energy consumption, namely by adjusting the packet size or using aggregation techniques.

— The most profound technologies are those that disappear. They weave themselves into the fabric of everyday life until they are indistinguishable from it.

Mark Weiser

4

An IEEE 802.11 Energy Efficient Mechanism for Continuous Media Applications

THIS chapter presents the Optimized Power save Algorithm for continuous Media Applications (OPAMA), which aims to improve the IEEE 802.11 energy efficiency for Continuous Media Applications (CMAs). Section 4.1 introduces the problem, followed by the OPAMA proposal presentation in Section 4.2. The assessment of OPAMA performance, in the OMNeT++ simulator and using the developed hybrid video quality assessment methodology, is described in Section 4.3. Finally, Section 4.4 presents the chapter summary.

4.1 Introduction

The opportunity to connect mobile equipment, sensors, actuators and other devices to the Internet, usually referred as Internet of Things (IoT) [Tozlu et al., 2012], raises

4. An IEEE 802.11 Energy Efficient Mechanism for Continuous Media Applications

new challenges in the deployment of those equipments. The battery lifetime is still one of the most relevant challenges, since it is directly affected by the device communication capabilities. Despite numerous efforts to create alternative low power radio technologies, IEEE 802.11 seems to be the *de facto* standard for wireless communications in most common scenarios. Therefore, it is crucial to investigate and propose mechanisms aimed at saving energy while providing Internet access through an IEEE 802.11 ready interface.

Furthermore, the massive deployment of high demand Continuous Media Application, namely Video on Demand (VoD) or Internet Protocol Television (IPTV), also enforces new requirements with respect to the equilibrium between energy efficiency and application performance. Besides specific application constraints, other aspects may be considered, such as end-user guidelines about whether or not energy saving is mandatory. For instance, the end-user configuration can be related with daily mobility or traveling patterns. As the end-user battery lifetime expectations are extremely hard to predict, the inclusion of end-user feedback in the optimization process will bring relevant benefits.

This chapter proposes Optimized Power save Algorithm for continuous Media Applications (OPAMA). OPAMA improves devices' energy consumption considering both end-user and application specific requirements, together with an optimized IEEE 802.11 power saving scheme and frame aggregation technique. Apart from using distinct application sources in the performance assessment, this chapter also describes additional performance evaluation results concerning OPAMA algorithm parameters configuration. Additionally, a hybrid (simulation and testbed) Quality of Experience (QoE) measurement methodology is proposed, allowing the discussion about end-users' perceived quality along all studied scenarios.

4.2 Optimized Power Save Algorithm for Continuous Media Applications (OPAMA)

This section describes the Optimized Power save Algorithm for continuous Media Applications.

4.2.1 Motivation

Mobile end-user energy constraints are still one of the critical issues to be addressed in wireless communication protocols, particularly at the MAC Layer. IEEE 802.11, the

4.2 Optimized Power Save Algorithm for Continuous Media Applications (OPAMA)

most popular in real world equipment wireless technology, uses the Power Save Mode (PSM), usually referred in the literature as Legacy Power Save Mode (Legacy-PSM), to limit energy consumption. However, the Legacy-PSM does not bring considerable energy savings in the presence of continuous media applications (e.g., video or voice), due to protocol design limitations, as explained next.

Legacy-PSM buffers traffic at the Access Point to all the stations operating in PSM mode, which indicates that they are in a *doze* state. A simplified Legacy-PSM operation example is depicted in Figure 4.1, where *STA-1* is operating in a *doze* state, while being served by the *AP-1*. *STA-1* must wake-up to receive the *Beacons* sent by the *AP-1* at the beginning of each *Beacon Interval*. When broadcasting a *Beacon*, an Access Point supporting PSM must look for pending packets for each station in a *doze* state that is currently associated with the Access Point. If there is data pending for a certain station, the Access Point reveals it through the TIM field present in the *Beacon* (e.g., *Beacon-2* indicates pending data for *STA-1*).

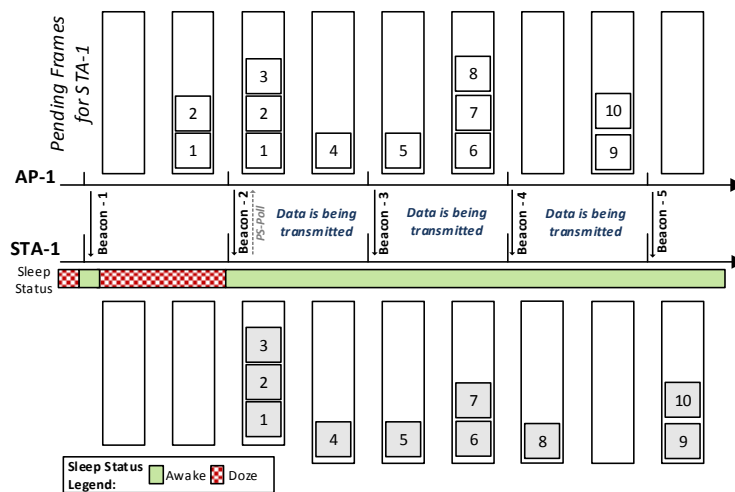

Figure 4.1: Legacy PSM algorithm operation example.

When receiving a *Beacon*, a station analyzes the TIM to verify the pending information existing in the Access Point buffer. If there is pending data, the station sends back a *PS-Poll* message to the Access Point asking for the data (e.g., *STA-1* asks for pending data upon receiving *Beacon-2*). The Access Point may reply with a single acknowledgement (ACK) or directly with the pending data frames. Then, the station must stay awake while the *MoreData* flag is set. The AP will set this flag while there is data to be delivered, whereas the station should send back a *PS-Poll* for each pending frame.

4. An IEEE 802.11 Energy Efficient Mechanism for Continuous Media Applications

The obvious trade-off when employing Legacy-PSM is the extra delay introduced by the queuing mechanism. The delay of a certain frame, f , can be expressed as $d(f) = t_{PS-Poll}(f) - t_{Arrival}(f)$. In this equation $t_{PS-Poll}(f)$ represents the time when the $PS-Poll$ to retrieve the frame f was received by the Access Point, and the $t_{Arrival}(f)$ indicates the arrival time of frame f to the Access Point queue.

If a station is operating in sleep state, $t_{PS-Poll}(f)$ is directly related with the *Beacon Interval*, BI , since, the Access Point announces pending data for a certain station using the TIM field within the *Beacons*. Therefore, the minimum possible delay for the f -th frame can be expressed as $d_{min}(f) = BI - (t_{Arrival}(f) \bmod BI)$. The minimum delay represents the time between the frame arrival and the time until the next *Beacon*. This behavior is only possible assuming that the $PS-Poll$ message can be sent to the Access Point by the station upon receiving the *Beacon* containing pending data information.

The Legacy-PSM specification clearly indicates that a station must stay awake when there is pending traffic to be delivered. When receiving data from a continuous media application (periodically sending data), the station will not be able to stay in a *doze* state for long, as there will be almost always data to be received. As a result, even if the device battery is near a critical threshold, it will not be possible to save energy by employing Legacy-PSM. Such behavior is clearly shown in the Legacy-PSM operation illustration in Figure 4.1, since once the application starts continuously sending data, *AP-1* does not allow *STA-1* to go back into sleep, as it always has data to be received. A detailed discussion concerning PSM operation and buffer-related issues at the Access Point was performed by Zhu et al. [Zhu et al., 2012].

OPAMA addresses these issues by introducing the expected end-user performance feedback in the process, allowing better control opportunities at the Access Point.

4.2.2 Architecture

The main goal of OPAMA is to allow the end-user to save energy while keeping a desired quality at the application level. For instance, when the device battery is low, the end-user might like to have the possibility to slow down the transmission performance to a certain level in order to save energy. To accomplish this goal, the station sleep periods must be maximized. Consequently, OPAMA will manage the Access Point buffer differently when compared to Legacy-PSM. While Legacy-PSM will always inform the station about any pending data, OPAMA will employ an algorithm based on the end-user expectations for the application performance to decide when pending data information should be sent to the station. As Legacy-PSM, OPAMA

4.2 Optimized Power Save Algorithm for Continuous Media Applications (OPAMA)

pending packets will stay in the Access Point queue. As a result, this operation will not affect the Legacy-PSM standard protocol [Adams and Muntean, 2007].

Figure 4.2 depicts a simplified operation scenario of OPAMA. *STA-1* is operating in a doze state, and it is being served by *AP-1*, which is then connected to the core network (not represented here).

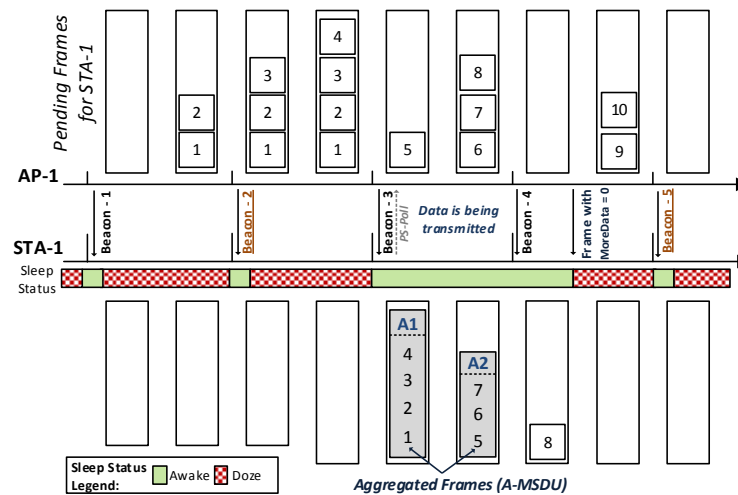

Figure 4.2: OPAMA algorithm simplified operation example.

OPAMA operates as follows: *STA-1* has left the *doze* state to receive *Beacon-1*. As there are no pending frames to be delivered, it just goes back into sleep mode. The first data for *STA-1* arrives at *AP-1* when the station is sleeping, so it is buffered. Again, *STA-1* becomes awake to receive *Beacon-2*. At this moment, there is already pending data for the station. However, OPAMA will employ a specific algorithm (Algorithm 1) to determine whether *STA-1* should be informed about pending data. In the example of Figure 4.2, the algorithm returned false and the TIM of *Beacon-2* does not include information about pending data for *STA-1*. The pending data information is only sent within *Beacon-3*, followed by the data transmission start upon receiving the *PS-Poll* message. Later, in *Beacon-5* OPAMA decides again to queue the frames for a longer time, allowing *STA-1* to return into the *doze* state despite pending data being available.

When the frames stay longer in the Access Point queue there are more opportunities to perform aggregation, as represented in Figure 4.2. In this case, *Frame-1*, *Frame-2*, *Frame-3* and *Frame-4* were aggregated using the A-MSDU scheme into *Frame-A1* and *Frame-5*, *Frame-6* and *Frame-7* into *Frame-A2*. The number of frames present in each A-MSDU is dynamic and depends on the total amount of bytes to be sent. As a result, *Frame-A2* carries fewer frames than *Frame-A1*. *Frame-8* was sent without aggregation,

4. An IEEE 802.11 Energy Efficient Mechanism for Continuous Media Applications

since there is only a single frame to be sent.

Although OPAMA enables the possibility of receiving station feedback in the Access Point, and uses such information to manage the pending frames accordingly, it does not specify any mechanism to control the values sent by each station. This option will ensure a superior control at the end-user side, allowing each station to determine what should be taken into account to define the maximum allowed delay. For instance, the maximum allowed delay can be configured by the end-user as a fixed value or dynamically calculated using application performance data.

The end-user feedback will be transmitted to the access point using two distinct messages, *PS-Poll* and *NullData*. The first message is used to request data from the Access Point, while the latter is an empty message used to inform the Access Point about shifts between two distinct power modes (e.g., going to sleep). Therefore, these message types are only transmitted from station to Access Point and they do not carry payload data. OPAMA will add one extra byte field to the “Frame Body” of these messages, allowing the stations to inform the Access Point about the maximum allowed delay.

The IEEE 802.11-2012 standard defines the *PS-Poll* frames as “Control” type, while the *NullData* frames belong to the “Data” type. The *subtype* value is 10 and 4, respectively, for *PS-Poll* and *NullData*. The combination of frame type and subtype allows unique identification of the frame function. Figure 4.3 depicts the IEEE 802.11 generic frame format and details the frame control field where frame type and subtype are presented.

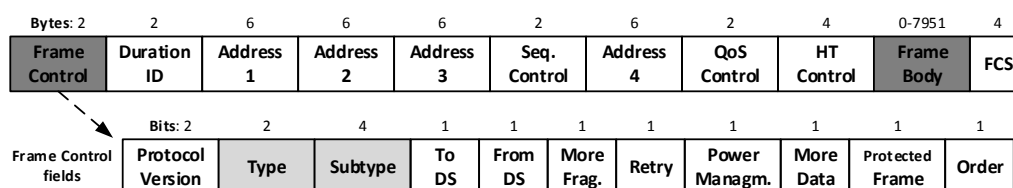

Figure 4.3: IEEE 802.11 MAC frame format (as in IEEE 802.11-2012 standard).

As OPAMA introduces an extra byte to transport Station Maximum Allowed Delay (STA-MAD) information, the standard frame content was changed. Therefore, to enable the proper deployment, while keeping the standard messages unaltered, there was a need to create a new unique identification for these two messages. The identification was done by selecting a frame subtype value not in use (usually named “Reserved” value). The extended *PS-Poll* and *NullData* frames were named, respectively, *OPAMA-PS-Poll* and *OPAMA-NullData*, and use the reserved frame subtypes 6 and 13.

4.2 Optimized Power Save Algorithm for Continuous Media Applications (OPAMA)

By using the extra STA-MAD information byte, each station can send a value within the [0,255] interval. However, the Access Point will perform an operation to calculate the STA-MAD value to be employed. The *STA-MAD* in milliseconds for a station, s , is given by $STA-MAD(s) = CONFIGURED-STA-MAD(s) \times 10$, where $CONFIGURED-STA-MAD(s)$ is the last STA-MAD value for the station s received by the Access Point. This action is performed by STA-MAD variable refresh depicted in (line 3) of the algorithm.

The decision to determine whether pending data information should be sent is performed by OPAMA, as defined in Algorithm 1. First of all, OPAMA gets all the reference values needed to execute the algorithm, such as the maximum delay allowed by the station or the aggregation limit support. Later, OPAMA analyzes the pending frames for the current station, starting by verifying the delay related constraints (lines 12 to 19).

When analyzing each frame, OPAMA also updates the total pending bytes to be sent (line 25) and performs an application dependent assessment (lines 20-24). Actually, OPAMA provides specific mechanisms for video applications, where the main goal is to ensure that no more than a defined number of video key frames (α parameter in line 21) will be queued. The video key frames parameter is specific to video applications, but all the other mechanisms can be used with mixed traffic scenarios. The performance when handling combined application scenarios might depend on end-user preferences. For instance, the STA maximum allowed delay can be defined by the end-user using an algorithm designed to select the best parameter according to the end-user high level preferences for each application type.

As previously discussed, the delay for a frame, f , when employing the standard Legacy-PSM is expressed as $d(f) = t_{PS-Poll}(f) - t_{Arrival}(f)$. When using the OPAMA algorithm, the maximum delay, *OPAMA-Max-Delay*, for the f -th frame is given by $OPAMA-Max-Delay(f) = STA-MAD(s) - (STA-MAD(s) \bmod BI) - (t_{Arrival}(f) \bmod BI)$. $STA-MAD(s)$ represents the configured maximum allowed delay for the station s . The minimum delay for OPAMA is the same as the minimum delay for the Legacy-PSM. Concerning the algorithm complexity, OPAMA is similar to the Legacy-PSM, as the only difference of the proposed algorithm is the queuing management approach.

Additionally, the algorithm also analyzes the maximum allowed number of aggregated frames to be sent using the station aggregation limit information ($Aggregation_{Threshold}$) and the total size of current pending data. The parameter β (line 27) controls the maximum number of aggregated frames, which can be queued for a certain station. The configuration of this parameter might also be performed using dy-

4. An IEEE 802.11 Energy Efficient Mechanism for Continuous Media Applications

Algorithm 1 Determine whether pending data information should be sent to a certain STA

```

1: function SEND_PENDING_DATA_TO_STA_DECISION( $STA_{MacAddress}$ )
2:   ▷ Update the STA-MAD variable with information received from the STA in the
   OPAMA-PS-Poll or OPAMA-NullData frames.
3:    $STA\_MAD \leftarrow getConfiguredSTAMAD(STA_{MacAddress}) \times 10$ 
4:   ▷ Get the maximum aggregation defined by the IEEE 802.11 version
5:    $Aggregation_{Threshold} \leftarrow getAggregationThreshold(STA_{MacAddress})$ 
6:   ▷ Get the time until sending next beacon
7:    $TimeUntilNextBeacon \leftarrow getTimeUntilNextBeacon()$ 
8:   ▷ Get queued frames list for the STA
9:    $STAFrameQueue \leftarrow getPendingFramesQueue(STA_{MacAddress})$ 
10:   $TotalPendingBytes \leftarrow 0$ 
11:  for each  $f$  in  $STAFrameQueue$  do
12:    ▷ Check if actual frame delay is greater or equal than the maximum delay defined by STA
13:    if  $getActualDelay(f) > STA\_MAD$  then
14:      return TRUE
15:    end if
16:    ▷ Check the STA-MAD limits for the frame  $f$ 
17:    if  $(getActualDelay(f) + TimeUntilNextBeacon) \geq STA\_MAD$  then
18:      return TRUE
19:    end if
20:    if  $f_{MediaType} == \text{"video"}$  and  $f_{FrameType} == \text{"I"}$  then
21:      if  $get\_Total\_Video\_KeyFrames\_Pending\_To\_STA(STA_{MacAddress}) > \alpha$  then
22:        return TRUE
23:      end if
24:    end if
25:     $TotalPendingBytes \leftarrow TotalPendingBytes + sizeOf(f)$ 
26:  end for
27:  if  $(TotalPendingBytes/Aggregation_{Threshold}) \geq \beta$  then
28:    return TRUE
29:  end if
30:  return FALSE ▷ Pending data information will not be sent
31: end function

```

dynamic approaches where, for instance, the network conditions or frames queuing time in lower layers (e.g. physical) are considered. The aggregation threshold information is associated with each station (*line 5*), since the maximum feasible aggregation size is related to the station MTU.

The aggregation method employed in the OPAMA algorithm is the Aggregated MAC Service Data Unit (A-MSDU). This technique is defined in the IEEE 802.11 standard, and it is mandatory, at the receiver side, in all devices compliant with IEEE 802.11n. By using such approach OPAMA becomes fully compliant with the IEEE 802.11 standard aggregation techniques, which might enable a faster deployment of the proposed algorithm. The main goal of the A-MSDU technique is to allow multiple

MAC Service Data Units (MSDUs) with the same source and destination to be sent in a single Mac Protocol Data Unit (MPDU). Figure 2.1, in Section 2.1.1, depicts the A-MSDU aggregation scheme.

There is no limit of subframes to be included, but the maximum A-MSDU length defined in the standard is 7935 bytes. It should be highlighted that although the A-MSDU scheme is defined in IEEE 802.11, the standard only specifies messages format and types, to allow the standardization of encapsulation and decapsulation phases. However, the IEEE 802.11 standard does not establish an aggregation control policy. The aggregation policy is out of the scope of the standard, and must be defined afterwards as it has been done in OPAMA.

The following section presents detailed information concerning OPAMA performance when compared with Legacy-PSM and when No-PSM is used.

4.3 Performance Evaluation

This section shows the OPAMA evaluation performed in OMNeT++ and in a real testbed. First, a novel hybrid empirical methodology to assess video Quality of Experience within OMNeT++ simulator is presented, followed by the presentation of the simulation details and configuration parameters. Finally, a detailed OPAMA performance comparison analysis is done, including OPAMA performance against Legacy-PSM and No-PSM case, and a study concerning OPAMA key configurable parameters.

4.3.1 Video Quality Assessment in OMNeT++

The quality assessment is historically associated with the evaluation of performance parameters at the network layer. However, the common metrics associated with Quality of Service (QoS), namely the available bandwidth, delay or packet loss rate have as main drawback the inability to represent the real quality perceived by end-users at application level. To overcome this limitation the concept of Quality of Experience (QoE) has been developed. The QoE can also be related with the devices' energy consumption, since the end-users aim at saving energy, but keeping the quality level within acceptable bounds.

Therefore, it is important to assess the video Quality of Experience perceived by the end-users and establish a proper relationship with the energy needed to transmit such video data. As, according to the best of our knowledge, there is no application to be used within OMNeT++ able to perform video Quality of Experience assessment,

4. An IEEE 802.11 Energy Efficient Mechanism for Continuous Media Applications

the empirical video assessment methodology proposed in Chapter 3 was extended. All the specific features of video streaming, such as frame types and sending times, are collected with the aid of the Evalvid tool [Klaue et al., 2003]. A similar proposal to integrate Evalvid in the NS-2 simulator was performed by Ke et al. [Heng Ke et al., 2008] as a new framework, and Lo et al. [Lo et al., 2005] have also employed an identical approach using NS-2 and Evalvid to assess video streaming quality over UMTS/WCDMA dedicated channels.

Figure 4.4 illustrates the proposed methodology to assess video quality within the OMNeT++ simulator. The video assessment methodology proposed in this work is a hybrid approach, meaning that it uses both OMNeT++ simulator and a real machine to assess the video quality. The simulator is used to transmit and capture both video and network information, while the real machine is employed to perform the remaining empirical evaluation procedures, such as “Received Video File Reconstruction” and “Video Quality Assessment”.

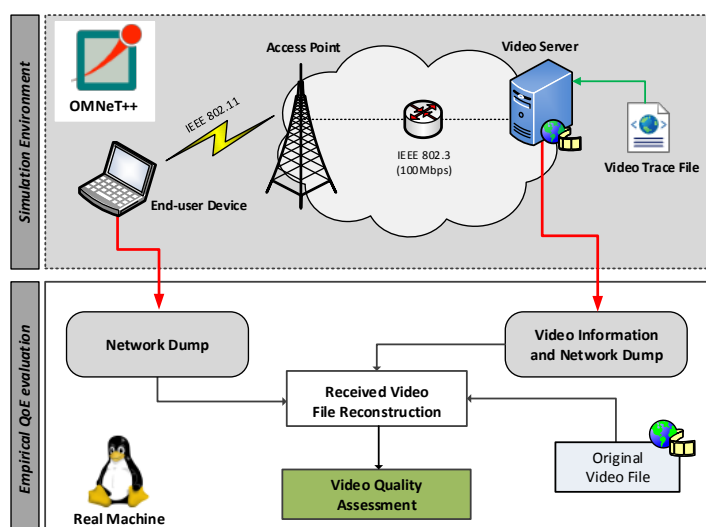

Figure 4.4: Video quality assessment methodology for OMNeT++ simulator.

The video traffic generation is performed using a client / server logic, where there is a “Video Server” entity transmitting video streaming to a certain “End-user Device”. First, the raw video data compression must be performed, where a raw lossless YUV video is compressed to be sent to the end-user. The codec that will be used and all the compression tools should be selected in accordance with the specific requirements of the assessment goals. All the video-related procedures needed to prepare the video streaming are done in the real machine.

Apart from supplying a set of scripts to prepare the video compression, when used in a real environment, the methodology proposed in Chapter 3, also provides the tools and scripts required to start all the procedures associated with the video streaming. Here, as video streaming will be performed in OMNeT++, the methodology was extended to output a “*Video Trace File*” with all the video information, namely video frame type and size, packet fragmentation information, and start time. Additionally, a new OMNeT++ application module able to parse the “*Video Trace File*” was developed, allowing the emulated video streaming to be done.

The developed OMNeT++ video streaming application, installed in the “*Video Server*” entity, starts the transmission and simultaneously captures the information about the transmitted video. The same network capture is performed by the application at the receiver side until the video transmission ends. The network information about the transmitted packets is collected using the well known *libpcap* library format.

Once the OMNeT++ simulation ends, both video and network information collected from the sender and receiver are sent back to the real machine. There, the received video is reconstructed frame by frame using the captured information and the source video file. Thus, the reconstructed coded video is transformed back into raw YUV format, in order to perform the video quality comparison with the original *lossless* raw YUV video.

The basic video quality is assessed through packet or frame loss, end-to-end delay, rate information and Peak Signal Noise to Ratio (PSNR) [Huynh-Thu and Ghanbari, 2008]. Additionally, video quality is also assessed through QoE metrics, such as Structural Similarity Index (SSIM) [Wang et al., 2004]. SSIM is an objective and full reference image quality metric, which measures the similarity between two images. It is based on three different similarity components, namely the contrast, the luminance and the structural similarity. Unlike PSNR, which is incoherent with Human Visual System characteristics, such as human eye perception, SSIM takes into consideration human eye perception parameters, which improves the evaluation accuracy. Therefore, the resulting SSIM is a combination of the three similarity parameters into a single value between 0 and 1, where 0 means no correlation with the original image, and 1 means the exact same image.

Apart from the various assessment metrics, the employed assessment framework also allows the configuration of a playout buffer parameter. However, this playout buffer is just a parameter used to control the received video file reconstruction, as it only “converts” frame delay into loss. Additionally, this delay to frame loss “conversion” also takes into account the video group-of-picture (GOP) structure. For example,

4. An IEEE 802.11 Energy Efficient Mechanism for Continuous Media Applications

the excessive delay of a key-frame (i.e., I-frame) will make the reconstructing procedure to discard all correlated frames. This behavior represents the frame dependency of the video (de)coding process. Such behavior is very important to allow accurate testing of the OPAMA algorithm. The configured playout buffer parameter during all the following tests was 200 ms. This value was defined by the IEEE 802.11 working group usage model as the maximum delay for Internet video/audio streaming applications [A. P. Stephens et al., 2004].

All the videos reconstructed using this framework will have the same total duration as the original video streamed. This is a strong limitation to study the impact of delayed video quality using the Temporal Quality Metric proposed in the ITU-T Rec. J.247 [ITU-T, 2008], which performs a superior analysis concerning the delay impact on the video quality. However, it allows a suitable quality comparison using video quality metrics such as SSIM, which can take losses into account but not delay or jitter.

The following subsection presents the OMNeT++ simulation scenario as well as the most relevant configuration parameters, including the video related information.

4.3.2 Simulation Scenario and Setup

The assessment of OPAMA was performed with two objectives. First, it aims to evaluate the impact of the proposed mechanism on energy consumption, delay and end-user attained Quality of Experience, when compared to Legacy-PSM and No-PSM scenarios. Second, it aims to assess the impact of OPAMA parameters configuration on the algorithm performance.

The tests were conducted in the OMNeT++ 4.2.2 [Varga and Hornig, 2008] simulator together with the INET Framework 2.0.0. As one of the main goals of this work is to study energy consumption in the IEEE 802.11 interfaces, a multimeter like module, based on the existing INET Framework battery model, was created. This module can measure energy consumed in an IEEE 802.11 interface, by computing the time spent in each state. The simulation scenario used is illustrated in the upper half of Figure 4.4.

Table 4.1 illustrates the power values [Camps-Mur et al., 2012] used for each considered state in the IEEE 802.11 physical layer implementation and the key parameters defined for the simulation. Both Legacy-PSM and OPAMA were implemented using the OMNeT++ INET framework. The IEEE 802.11 radio Bit Error Rate (BER) used in this simulation study results from values obtained for various IEEE 802.11g physical modes, using a dedicated Orthogonal Frequency-Division Multiplexing (OFDM)

Table 4.1: OMNeT++ simulation parameters.

Parameter	Value
Total simulation time	660 seconds
Number of Runs	20
IEEE 802.11 - Operation mode	G
IEEE 802.11 - Beacon interval	100ms
IEEE 802.11 - Aggregation type	A-MSDU
Radio - Attenuation threshold	-110dBm
Radio - Maximum sending power	2.0mW
Radio - SNIR threshold	4dB
Radio - BER table	"per_table_80211g_Trivellato.dat"
Power while transmitting	2000mW
Power while receiving	1500mW
Power while idle	390mW
Power while sleeping	20mW
OPAMA α parameter	10
OPAMA β parameter	5

physical layer simulator. The OPAMA related configuration is performed by defining both α and β parameters, used in Algorithm 1.

The assessment of OPAMA was performed using the freely and publicly available "Elephants Dream" raw sequence [Blender Foundation / Netherlands Media Art Institute, 2015][Van der Auwera et al., 2008]. This sequence was encoded with H.264/MPEG-4 AVC codec using a Variable Bit Rate (VBR), and has a resolution of 352x288, containing 14400 frames. All the movies were coded using a Group Of Pictures (GOP) of 12 frames with 24 Frames Per Second (FPS). All the video-related operations were performed using *ffmpeg* software [Tomar, 2006]. The video is played for 10 minutes.

Three distinct video qualities were selected for the tests, as summarized in Table 4.2. The end-users' perceived Quality of Experience, given by the SSIM metric, is obtained in a real testbed by employing the hybrid video quality assessment methodology defined in Section 4.3.1.

Table 4.2: Parameters of compressed video sequences

Name	CRF	Avg. Bitrate	Reference PSNR	Reference SSIM
Video-Q1	26	340 kb/s	39.63±5.49	0.97±0.02
Video-Q2	22	539 kb/s	42.27±5.65	0.98±0.01
Video-Q3	18	845 kb/s	44.99±5.82	0.99±0.01

4. An IEEE 802.11 Energy Efficient Mechanism for Continuous Media Applications

The video encoding was performed using the *x264* encoder and employing the Constant Rate Factor (CRF) or Quality Constant method, which is the default quality setting for this encoder. The CRF method keeps a constant quality along the video by compressing all the frames with the same quality, resulting in a variable bit rate movie. In this work three different CRFs (18, 22 and 26) were selected and mapped into three different video qualities, *Video-Q1*, *Video-Q2* and *Video-Q3*, respectively. The CRF scale ranges from 0 to 51, where 0 is lossless, 23 is the default compression and 51 represents the worst possible quality.

All the results presented in the following sections include 20 runs using distinct random seed numbers with a confidence interval of 95%.

4.3.3 Results

This subsection presents the validation of OPAMA algorithm basics, followed by its performance assessment compared with Legacy-PSM and No-PSM schemes.

4.3.3.1 Validation of Algorithm Basics

The analysis presented next has two main goals. First, it supports the validation of the OPAMA information exchange within the defined messages. Second, it aims at studying the algorithm on both network performance (i.e., delay) and energy consumption.

During these tests, to compare and validate, the information concerning STA-MAD sent by the station to the Access Point is always set to zero (i.e., STA-MAD=0 ms). This configuration allows the implementation to be properly tested against Legacy-PSM and No-PSM.

Since with STA-MAD=0 ms, OPAMA will not be able to queue frames, as it will also not be possible to perform aggregation. As it is important to validate the implemented A-MSDU aggregation mechanism, a common aggregation policy was defined for this scenario. Such policy encompasses the aggregation of all the packets arriving within a small interval (≤ 5 ms). The maximum aggregation size was defined as 2272 bytes, which is the IEEE 802.11g MTU. This configuration will allow a proper validation against the Legacy-PSM. With the stated configuration, OPAMA will perform similarly to Legacy-PSM, but using the A-MSDU aggregation scheme. Additionally, the extra byte to carry STA-MAD information is exchanged in all the messages defined to transport such data.

Therefore, in order to perform a clear distinction between the usage of OPAMA with this restriction and the rest of the chapter, this limited version of OPAMA with

STA-MAD = 0 ms will be named as Legacy-PSM-Aggregation.

Figure 4.5 depicts a *boxplot* representing the end-to-end delay (in milliseconds) obtained for all the packets needed to stream each of the three distinct videos already presented (Table 4.2).

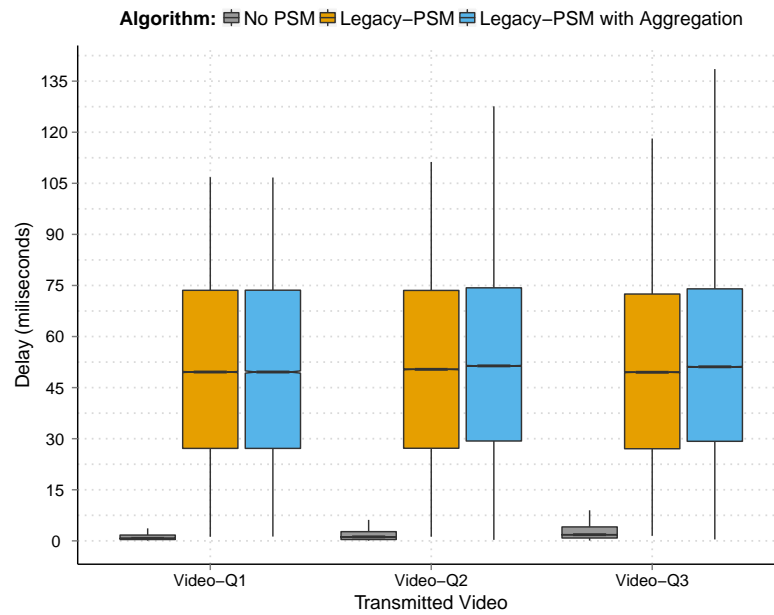

Figure 4.5: No-PSM, Legacy-PSM and Legacy-PSM with Aggregation end-to-end delay.

As expected, No-PSM shows a lower delay compared with both Legacy-PSM and Legacy-PSM-Aggregation. When assessing Legacy-PSM and Legacy-PSM-Aggregation performance it is noticeable that the delay is similar in both cases. The slightly higher maximum delay obtained with Legacy-PSM-Aggregation scenario is related with the employment of the A-MSDU aggregation technique.

The total energy consumed (in Joule) during the video transmission is illustrated in Figure 4.6.

The confidence interval limits are represented by the lines on the top of each bar. Although both Legacy-PSM and Legacy-PSM-Aggregation introduce extra delay, the energy savings are not significant. When employing Legacy-PSM the savings, compared with No-PSM scenario, are around 4.57%, 3.34% and 1.60% for *Video-Q1*, *Video-Q2* and *Video-Q3*, respectively. The savings while using Legacy-PSM-Aggregation are 8.42%, 8.46% and 9.59%, respectively.

When analyzing the energy consumption of Legacy-PSM and Legacy-PSM-

4. An IEEE 802.11 Energy Efficient Mechanism for Continuous Media Applications

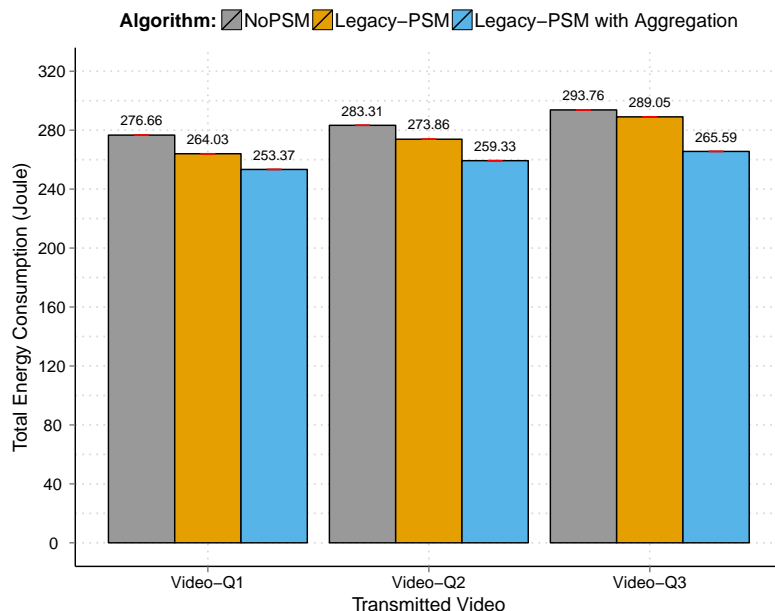

Figure 4.6: No-PSM, Legacy-PSM and Legacy-PSM with Aggregation energy consumption.

Aggregation, the latter achieves savings of 4.04%, 5.40% and 8.11%, respectively, for *Video-Q1*, *Video-Q2* and *Video-Q3*. These results clearly illustrate that solely employing aggregation is not able to solve all the energy related issues within continuous media applications. The lower energy consumption of Legacy-PSM-Aggregation depicts the benefits of aggregation in the overall energy consumption. Moreover, it is worth mentioning that the extra STA-MAD information byte does not have any impact on energy consumption.

Although these values do not constitute an optimal tradeoff between the extra delay introduced and the energy consumed, they showed the limitations of Legacy-PSM, particularly by depicting a performance degradation directly related with the video quality. As discussed previously, this behavior is mainly caused by the few sleeping opportunities of Legacy-PSM when using continuous media applications. Since those applications have almost always data pending to be transmitted, the possibilities for the station to sleep are very limited. It must be highlighted that unlike Legacy-PSM-Aggregation, OPAMA will be able to control whether or not the pending data information should be broadcasted to the station, allowing a better sleep period optimization.

The end-users' perceived Quality of Experience, assessed through the SSIM, shows that all the studied protocols can achieve the maximum possible QoE, as shown in

Table 4.2. Nonetheless, the SSIM values themselves do not reach the maximum (i.e., SSIM=1). The reason for this behavior is that the maximum possible SSIM for each sequence is directly related to the employed video data compression. The SSIM values illustrate their similarity compared with the corresponding lossless movies.

Apart from the discussed limitations and extra delay introduced, both Legacy-PSM and Legacy-PSM-Aggregation are able to provide the same quality as No-PSM. Although marginal energy savings can be noticed when employing Legacy-PSM and Legacy-PSM-Aggregation, it is not possible to improve the energy/quality tradeoff or to include the end-user expectations in the decision process. These limitations will be explored by the OPAMA algorithm.

The next subsection will study OPAMA performance when varying the Maximum Allowed Delay defined by the end-user.

4.3.3.2 Impact of STA Maximum Allowed Delay on OPAMA Performance

This subsection studies the impact of the maximum allowed delay defined by the station on the OPAMA performance. From now on, as the obtained results with the three distinct videos (*Video-Q1*, *Video-Q2* and *Video-Q3*) are similar, only *Video-Q2* will be used in the analysis. This sequence was selected since it represents a very good quality movie, being able to provide a very good quality perception to the end-users, achieving a SSIM=0.98 (Table 4.2). Figure 4.7 depicts a *boxplot* with the end-to-end delay (in milliseconds) in the y-axis. The x-axis represents the station maximum allowed delay (in milliseconds). To allow a proper performance comparison, the maximum allowed delay defined by the station was always kept constant in each test set.

The STA-MAD was never exceeded for all the test cases. By observing the *boxplots* mean values, it is possible to conclude that the end-to-end delay is around 50 ms in all the tested scenarios. The first quartile analysis shows that for 25% of the packets, the delay is about 30 ms, roughly the same as for both Legacy-PSM and Legacy-PSM-Aggregation (see Figure 4.5). Additionally, it is also possible to observe that 75% (third quartile) of the delivered packets have only a delay of around 75 ms. The *outliers*, depicted as red points, reveal some limitations of employing OPAMA with this configuration (see Table 4.1). In optimal conditions the maximum delay should be near the STA-MAD, since it will allow the station to sleep longer, while packets are queued in the Access Point. The study of OPAMA configuration parameters will be addressed later in this work. Nevertheless, this behavior can be explained by the strict delay control performed in conjunction with frame aggregation. OPAMA tries to maximize

4. An IEEE 802.11 Energy Efficient Mechanism for Continuous Media Applications

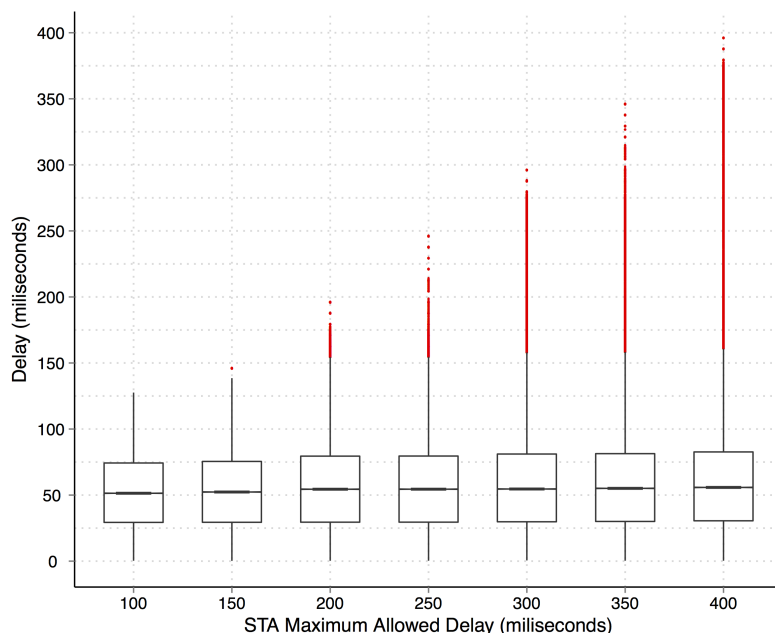

Figure 4.7: End-to-end delay for OPAMA with Maximum Allowed Delay defined by the STA.

the number of frames sent in each A-MSDU frame, but always without exceeding the station maximum allowed delay.

A comparison of the obtained energy savings regarding the employment of OPAMA, with both Legacy-PSM and No-PSM scenarios is shown in Figure 4.8. The y-axis represents the energy saved in percentage, while the maximum allowed delay (in milliseconds) defined by the station is depicted in the x-axis.

The results show benefits of using OPAMA when the station can accommodate some delay (e.g., by using local buffering techniques). The savings for STA-MAD = 100 ms when compared with the Legacy-PSM are around 5%, which in this particular case allows the end-user to play the video for almost 35 seconds longer using the same energy. The highest maximum allowed delays, such as 300 ms, boost the savings to around 15%. At a first glance, it might not seem interesting to employ such large delays. However, the station can dynamically inform the OPAMA ready Access Point about the maximum expected delay to reflect the end-user behavior and this value might also be adjusted according to desired preferences or settings.

Figure 4.9 shows the SSIM (y-axis) obtained for each configured station maximum allowed delay in milliseconds, depicted in the x-axis.

The SSIM for STA-MAD \leq 200 ms is the maximum possible using the compression

4.3 Performance Evaluation

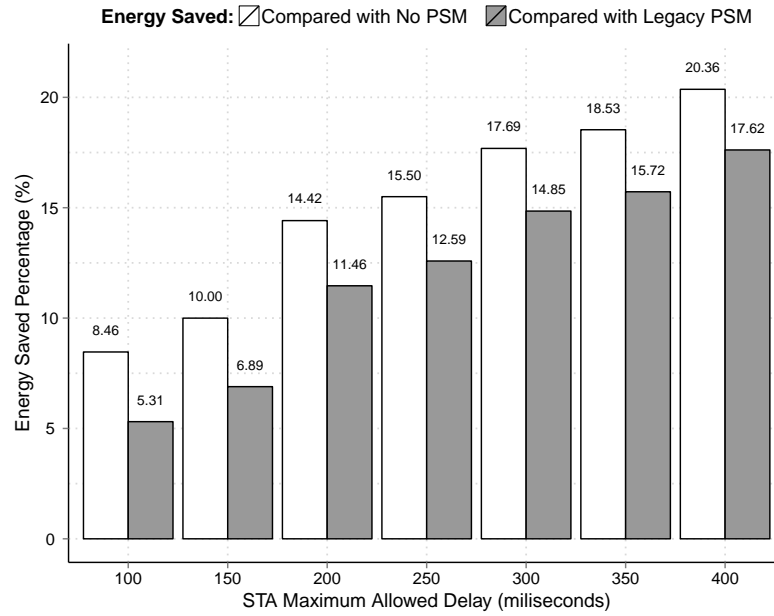

Figure 4.8: Energy savings with OPAMA, compared with Legacy-PSM and No-PSM scenarios.

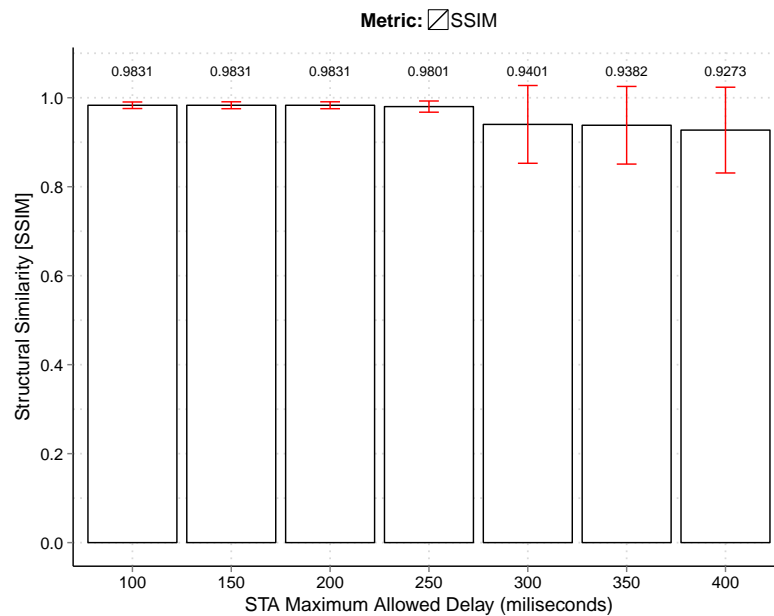

Figure 4.9: SSIM for OPAMA with Maximum Allowed Delay defined by the STA.

4. An IEEE 802.11 Energy Efficient Mechanism for Continuous Media Applications

employed in *Video-Q2*. When compared to the scenario with STA-MAD = 250 ms, the SSIM drops from 0.9831 ± 0.0078 to 0.9801 ± 0.0126 . In the highest maximum allowed delay scenarios there is already impact in the video quality perceived by the end-users. For instance, with a STA-MAD = 400 ms, the end-user perceived quality decreases to $SSIM = 0.9273 \pm 0.0964$. Notwithstanding the quality drop, the obtained SSIM values for the worst cases reveal OPAMA's capability to provide an acceptable video correlation to the end-users together with considerable energy savings.

4.3.3.3 Impact of α and β Parameters in OPAMA Performance

This subsection studies the impact of OPAMA core parameters (i.e., α and β) on the overall algorithm performance. As described during OPAMA introduction in Section 4.2.2, the α parameter defines the maximum number of queued data frames containing video key frames, while β controls the maximum allowed number of aggregated frames (A-MSDU) in the Access Point queue.

The relationship between the STA-MAD and the β value (ranging from $\beta = 1$ to $\beta = 30$) is depicted in the following figures. As presented in Table 4.1, the base configuration has $\beta = 5$.

Figure 4.10 depicts a *boxplot* for the end-to-end delay (in milliseconds) in the y-axis, while x-axis represents β configuration for each of the station maximum allowed delay.

In a station allowing a maximum delay of 100 ms, the β variation has no impact on the delay. Such behavior is explained by the strict control of the maximum allowed delay defined in the OPAMA algorithm. Before allowing frames to be queued, OPAMA checks whether there are (or will be) frames exceeding the defined STA-MAD. Therefore, once the delay restriction is violated, there are no benefits in allowing more frames to be queued by using a larger β . The impact of β on the achieved delay is noticeable when $STA-MAD \geq 150$ ms, as for these scenarios the queuing opportunities, generated by the bigger allowed delays, also increase.

By observing the β behavior along the various studied STA-MAD values, it is possible to notice that the lower β values (≤ 10) do not allow a vast percentage of the packets to be delayed by more than 100 ms. For instance, when $STA-MAD = 200$ ms and $\beta = 10$, there are 75% (third quartile) of the packets with a delay lower or equal than 80 ms, while the maximum delay (excluding the *outliers*) is near to 150 ms. A similar behavior can be noticed for all the cases with $STA-MAD \geq 200$ ms. Since the obtained delay is related to the capability of a station to sleep longer, it is crucial to

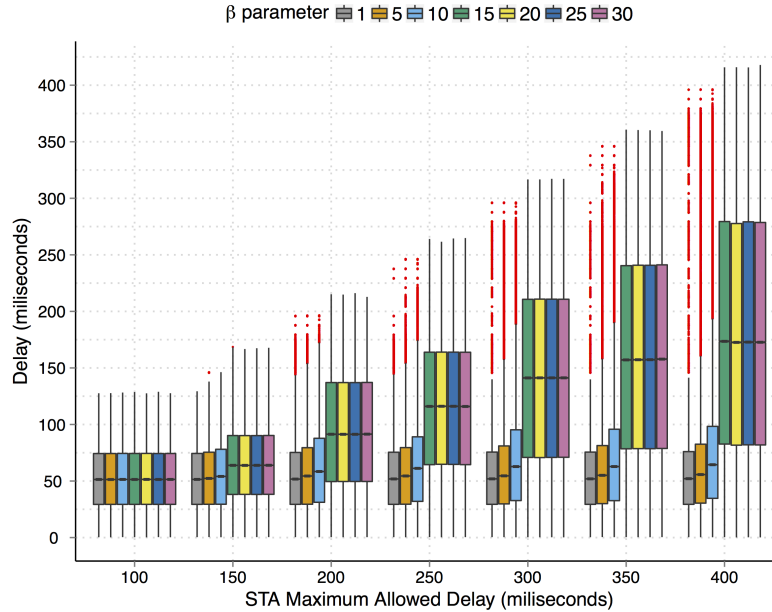

Figure 4.10: Delay for distinct β configurations and Maximum Allowed Delay defined by the STA.

maximize the delay up to the bounds defined by each station as the maximum allowed.

When parameter $\beta \geq 15$, unless for STA-MAD = 100 ms, one can observe that the mean delay is higher, when compared to cases with $\beta < 15$, and there are also no *outliers*. Both lower and upper quartiles depict higher values, and there is a bigger interquartile range (difference between the upper and lower quartiles), meaning that 50% of packets arrived within such delay interval.

The maximum delay obtained when $\beta \geq 15$ and STA-MAD ≥ 150 ms exceeds marginally the maximum delay allowed by the station. This is mainly due to the time needed for the Access Point to process and send all the queued frames to the network. Thus, packets inside the latest frames sent to the network might suffer some extra delay. Furthermore, there is almost no difference between the *boxplots* when $\beta \geq 15$, since the aggregation opportunities are first limited by the OPAMA delay control procedure. Consequently, as revealed by the obtained results, in this scenario it is not significant to have β values greater than 15.

The total energy consumption (in Joule) and the end-user perceived Quality of Experience (given by the SSIM metric), for the previously discussed scenarios, are illustrated in Figures 4.11 and 4.12, respectively.

4. An IEEE 802.11 Energy Efficient Mechanism for Continuous Media Applications

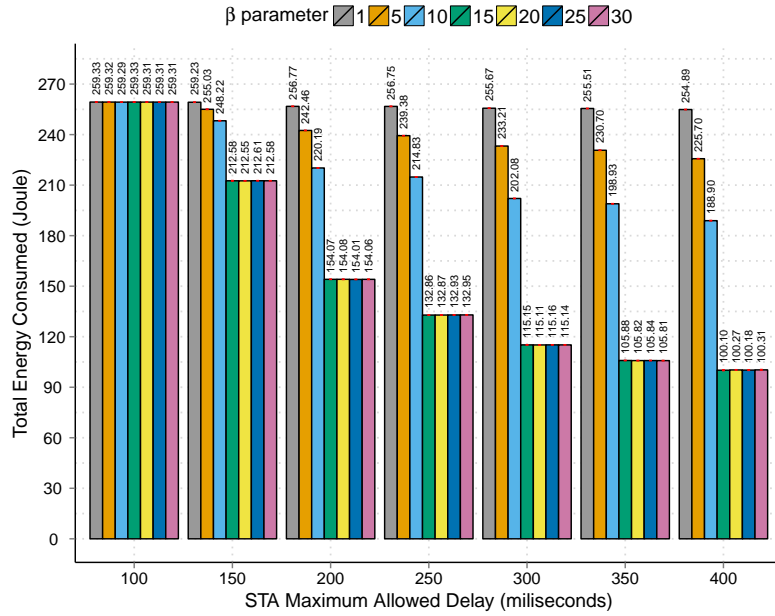

Figure 4.11: Energy consumption for distinct β configurations and Maximum Allowed Delay defined by the STA.

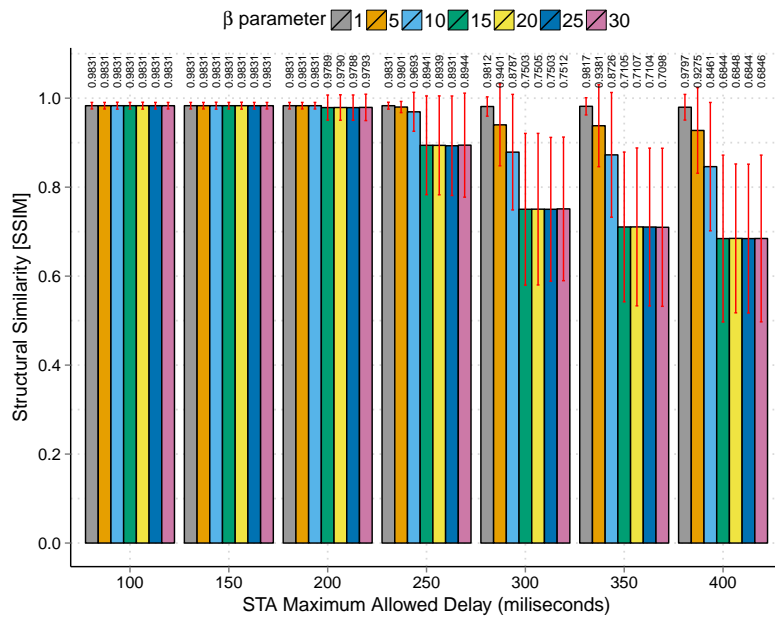

Figure 4.12: SSIM for distinct β configurations and Maximum Allowed Delay defined by the STA.

The depicted energy results show a clear relationship between the β configuration and the total energy consumption, unless when STA-MAD = 100 ms, as discussed previously. The energy consumption analysis reveals that the β configuration can considerably enhance the energy savings. Using the default setup with $\beta=5$, versus a configuration with $\beta=15$, improves energy savings from around 17% with STA-MAD = 150 ms to 36% and 56%, respectively, for STA-MAD equal to 200 ms and 400 ms. For the same scenarios, the energy savings compared with Legacy-PSM are 44% and 63%, respectively.

Nevertheless, the energy savings should be analyzed together with the obtained Quality of Experience (Figure 4.12), since the end-users are not only concerned about the used energy. The higher β values (≥ 15) have a direct impact on the quality perceived by the end-users providing a maximum delay greater or equal to 250 ms.

Even though the perceived quality is affected by both STA-MAD and β configuration, it still achieves an acceptable quality level for the worst cases. As an example, the scenarios with $\beta=15$ and STA-MAD = 400 ms (energy saving of 56%, compared with $\beta=5$ setup) obtain a SSIM = 0.6844, which is still an acceptable correlation with the original video, while in the STA-MAD = 200 ms (energy saving of 36%) the quality is roughly the same (SSIM = 0.9789) as the reference video. By establishing a proper cost/benefit tradeoff between the energy savings and the obtained quality, OPAMA gives end-users the opportunity to select the best configuration according to their preferences or energy levels.

A similar study, using the same parameters range, was performed for the α parameter. The study includes also two distinct β configurations ($\beta = 5$ (default) and $\beta = 15$). In the first case, the α parameter shows no influence on the results, mainly because other algorithm restrictions (delay and maximum allowed number of aggregated frames) were not satisfied. With $\beta = 15$, the study reveals a minor impact with $\alpha = 25$ and 30, introducing a negligible delay and an insignificant impact on both energy consumption and perceived quality. Nevertheless, it should be highlighted that the α parameter impact is closely related with the video characteristics and it might have a different impact in other videos where, for instance, the key frames are bigger.

4.3.3.4 OPAMA Performance with Larger MTU

OPAMA uses MAC layer aggregation (A-MSDU) as one of the algorithm components. Until now, all the tests were performed using a Maximum Transmission Unit (MTU) of 2272 bytes, which is the default for IEEE 802.11g. Nevertheless, in IEEE 802.11n,

4. An IEEE 802.11 Energy Efficient Mechanism for Continuous Media Applications

where aggregation at the receiver side is already mandatory, the MTU can be up to 7935 bytes. Therefore, this section investigates the OPAMA behavior with these two distinct MTUs. Additionally, the β parameter influence on OPAMA's performance, using those two MTUs, was also studied.

Figure 4.13 shows the end-to-end delay for MTU of 2272 and 7935 bytes, with two distinct values of β . The x-axis represents the maximum allowed delay by the station (STA-MAD) in milliseconds.

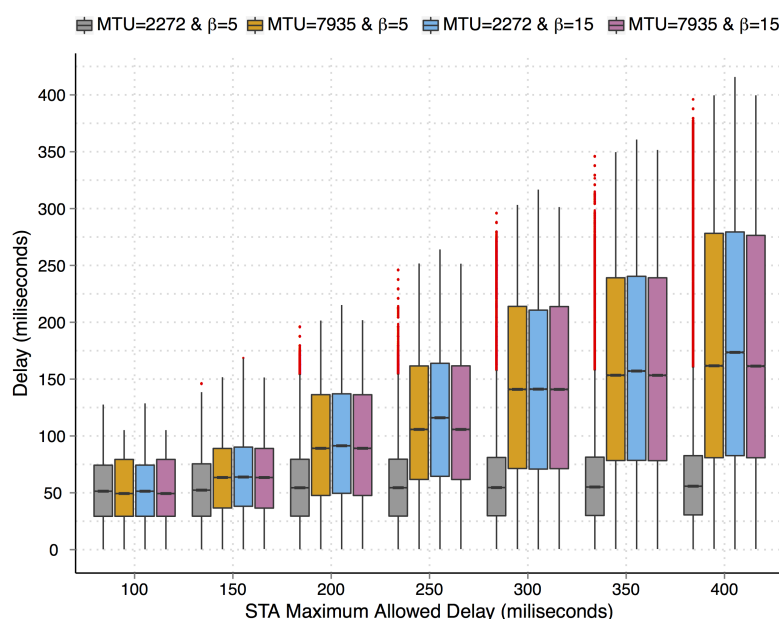

Figure 4.13: MTU impact on OPAMA delay.

When comparing the two MTU scenarios with $\beta = 5$ it is noticeable that the one with smallest MTU shows a lower mean delay, independent of the defined STA-MAD. This behavior is related to the OPAMA algorithm delay restrictions, as previously discussed in Subsection 4.3.3.2. Using the IEEE 802.11n default MTU (i.e., 7935 bytes) the mean delay starts to increase along with the STA-MAD, while the interquartile range also grows in the same proportion. Thus, in this scenario OPAMA introduces additional delay for almost all the delivered packets, but the maximum allowed delay defined by the station is never exceeded.

For the two MTU scenarios with $\beta = 15$ both configurations present a similar delay pattern, depicting a clear increase when compared with a scenario with $\beta=5$ and MTU = 2272 bytes. Nevertheless, unlike both scenarios with MTU = 7935 bytes, the

scenario with MTU = 2272 bytes and $\beta = 15$ exceed the maximum allowed delay for all the tested scenarios.

If only the end-to-end delay is analyzed, this might reveal poor OPAMA performance in scenarios with large maximum transmission units. However, the information regarding energy consumption, shown in Figure 4.14, highlights the opposite.

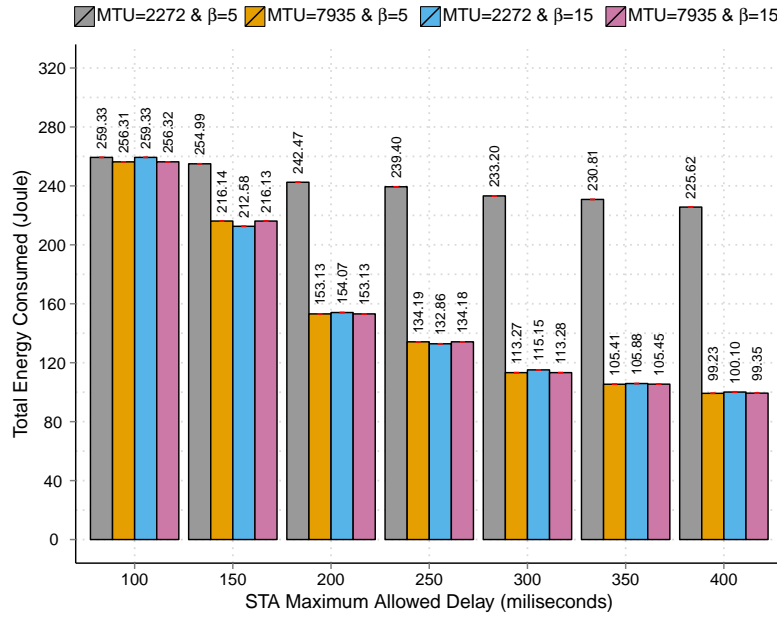

Figure 4.14: MTU impact on OPAMA energy consumption.

With a larger MTU (i.e., 7935 bytes), OPAMA introduces additional delay for almost all the delivered packets, but it also decreases significantly the energy consumption. A similar energy performance is achieved when using MTU = 2272 bytes and $\beta = 15$. This behavior can be explained by the higher aggregation opportunities created by the β configuration. The slightly higher energy consumption under these conditions is related with the energy costs of sending more frames to the network, when compared with the MTU = 7935 bytes case. Additionally, the usage of larger frames also reduces the number of MAC layer acknowledgments in the network, which reduces the global network contention and maximizes the station sleep time.

In the scenarios with $\beta=5$, the usage of 7935 bytes as maximum transmission unit, when STA-MAD = 100 ms, is able to achieve savings only of around 2%. This behavior can be explained by the characteristics of the video used during these tests, which has a packet inter-departure time that does not allow OPAMA to perform better within

4. An IEEE 802.11 Energy Efficient Mechanism for Continuous Media Applications

lower station delay restrictions. However, the savings for a station with a maximum allowed delay of 250 ms and 400 ms are 44% and 56%, respectively. Similar savings can be obtained using MTU = 2272 bytes with $\beta = 15$. However, a different behavior can be observed in the Quality of Experience perceived by the end-users, as illustrated in Figure 4.15. The station maximum allowed delay is plotted in the x-axis, while the SSIM is depicted in the y-axis.

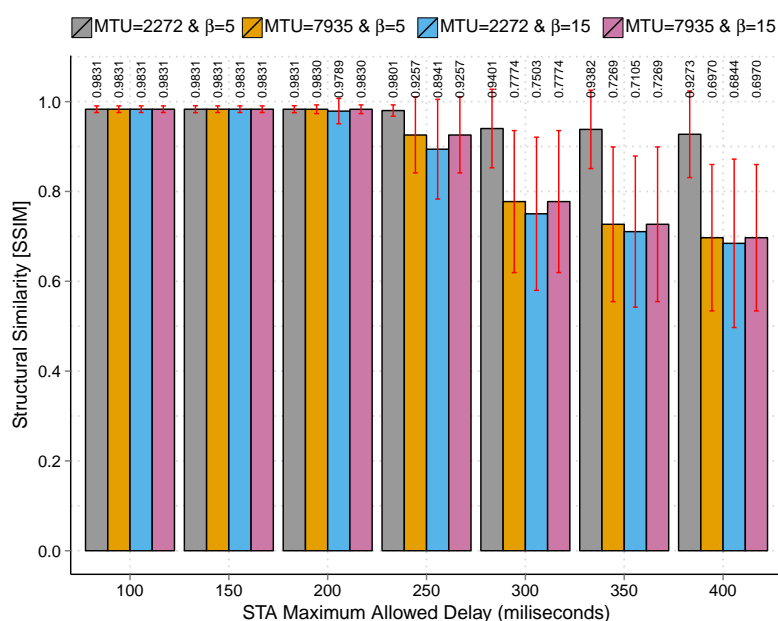

Figure 4.15: MTU impact on end-users' perceived quality.

When compared with Legacy-PSM case, a station with a maximum allowed delay of 200 ms and using a MTU of 7935 bytes can achieve energy savings of around 44% without degrading the video quality perceived by the end-users. Similar energy savings can be obtained by configuring OPAMA with $\beta = 15$ and using an MTU of 2272 bytes, although there is already a slight impact on the end-user quality of experience.

The results show OPAMA capabilities to benefit from larger MTUs, but also the possibility to achieve similar performance with smaller MTU, if a correct parametrization is performed. Therefore, OPAMA is able to improve the cost/benefit tradeoff between energy consumption and Quality of Experience, while keeping end-user satisfaction at a desired level.

4.4 Summary

The energy efficiency in end-user IEEE 802.11 ready devices is still an important factor towards a fast and global deployment of future mobile communication scenarios, since battery lifetime is one of the most critical factors in a daily usage. This chapter investigated and proposed a mechanism aiming at saving energy while supporting continuous media applications with a certain quality. The proposed power saving algorithm for IEEE 802.11 networks, named OPAMA, was designed to enhance the energy consumption by extending the IEEE 802.11 legacy PSM in order to accommodate the end-user feedback, and using Aggregated MAC Service Data Unit (A-MSDU) to deliver the data frames. Additionally, a novel hybrid (testbed and simulation) methodology able to evaluate the end-user perceived Quality of Experience (QoE) was also specified.

OPAMA performance assessment showed capabilities to improve energy efficiency in several scenarios, while keeping the end-user quality of experience at an acceptable level. When using IEEE 802.11g default MTU (2272 bytes) in the presence of optimal algorithm configuration, OPAMA can achieve energy savings up to 63% in a high tolerance to delay scenario and 44% for a scenario where the station can only accommodate a maximum delay of 200 ms. The Quality of Experience assessment also highlights the relationship between the energy saved and the obtained quality, with noticeable quality drops in the highest maximum allowed delay scenarios. Nevertheless, the usage of OPAMA allows end-users to select the best tradeoff between quality and energy consumption for the test scenarios under study.

The impact of MTU configuration in the proposed algorithm performance was also noticeable, showing benefits of using larger MTU whenever possible. When employing the IEEE 802.11n default MTU (7935 bytes), OPAMA performance with default configuration is similar to the optimal setup using the smaller MTU tested. Apart from the impact on the energy consumption, the usage of larger MTUs also showed benefits concerning the quality perceived by the end-users.

4. An IEEE 802.11 Energy Efficient Mechanism for Continuous Media Applications

*— If everything seems under
control, you're not going fast
enough*

Mario Andretti

5

Power Saving Mechanisms in Multiple Station Environments

THIS chapter discusses the energy-efficiency of various IEEE 802.11 energy saving mechanisms when used in a multiple station environment. Section 5.1 gives a brief introduction to the chapter goals and structure, followed by the presentation of the multiple station environment setup, used to perform the assessment along the chapter, in Section 5.2. The evaluation regarding the energy consumption of distinct energy saving mechanisms is discussed in Section 5.3. Section 5.4 presents the energy / quality trade-off issues raised by the usage of multiple stations, and proposes the Enhanced Power Saving Mechanism for Multiple station Environments (EPS4ME). Finally, Section 5.5 summarizes the chapter findings.

5.1 Introduction

The aforementioned fast deployment and growing of IEEE 802.11 wireless access networks enable scenarios where multiple stations are simultaneous accessing the net-

5. Power Saving Mechanisms in Multiple Station Environments

work through the same access point. To assess the real impact of this new trend on the end-users' network access expectations, it is important to investigate the trade-off between the number of active devices, energy consumption and perceived quality. However, until now most works study this subject only taking into account the throughput or energy savings gains, but do not assess the impact on the end-users' perceived quality.

As showed in Chapter 4, when compared to IEEE 802.11 Legacy-PSM, OPAMA proposal demonstrated capabilities to enhanced the energy savings within continuous media applications, while keeping the application QoE within limits defined. Nevertheless, the acceptable energy / quality trade-off obtained with this end-user driven power-saving approach should also be investigated within multiple station access environments.

Therefore, this chapter provides an extensive evaluation concerning the energy consumption and achieved quality to the end-users when multiple stations are present in the network. The assessment was performed in OMNeT++, using CBR synthetic and video VBR traffic sources.

The conducted analysis revealed a non negligible impact of the number of active stations on the quality perceived by the end-users. As a result, an Enhanced Power Saving Mechanism for Multiple station Environments (EPS4ME) specifically designed to addresses the issues raised by the multiple stations simultaneous access, has also been proposed and evaluated.

5.2 Simulation Scenario and Setup

This section presents the evaluation setup and configurations performed to study the impact of multiple stations on the distinct power saving mechanisms.

Following the previous chapter, the selected simulator was OMNeT++ 4.2.2 with the INET Framework 2.0.0. Due to the high number of stations to be used, N , it was not possible to perform this assessment in a testbed. Figure 5.1 depicts the scenario created to study the multiple station environment. All the Stations (STAs) (STA-1, STA2, ..., STA-N) are equally distant, r , from the AP. The distance between each STA, k , illustrated in the figure, can be obtained as follows: $k = \frac{2\pi \times r}{N}$. Such network deployment aims at enabling similar receiving conditions for all the associated stations. The remainder simulator configurations, namely all the IEEE 802.11 related parameters, defined in OMNeT++ are shown in Table 5.1.

All the IEEE 802.11 related parameters were configured as in OPAMA initial val-

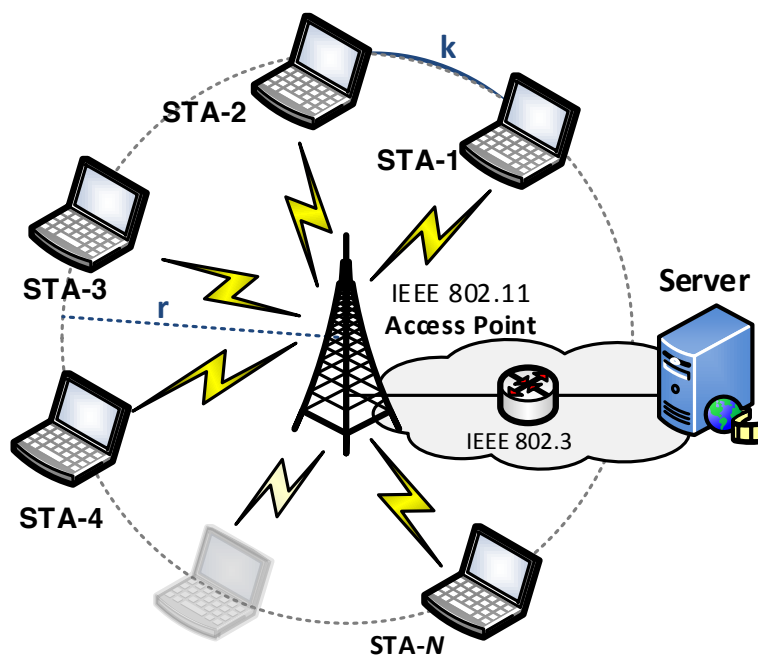

Figure 5.1: OMNeT++ simulation scenario with multiple stations.

validation and performance assessment (Table 4.1). As the main goal of this evaluation is to study the energy saving mechanisms behavior, a Constant Bit Rate (CBR) traffic source was selected to minimize the impact of the transport protocol on the results. The packet size was fixed as 600 bytes, since packet size impact on the overall energy consumption is negligible (see Section 3.4.4).

To enable a realistic radio Bit Error Rate (BER) model, the IEEE 802.11g radio of the multiple stations was configured using a bit error mapping file obtained from a dedicated Orthogonal Frequency-Division Multiplexing (OFDM) physical layer simulator.

5.3 Power Saving Mechanisms Performance within Multiple Stations Scenario

This section presents the obtained results concerning the evaluation of multiple station scenario. Subsection 5.3.1 presents a general discussion regarding the impact of the number of stations with the various energy saving mechanisms, namely No-PSM, Legacy-PSM, U-APSD and OPAMA. The OPAMA Station Maximum Allowed Delay (STA-MAD) configuration effect on the algorithm performance is later discussed in Subsection 5.3.2.

5. Power Saving Mechanisms in Multiple Station Environments

Table 5.1: OMNeT++ simulation parameters.

Parameter	Value
Total simulation time	350 seconds
Number of Runs	20
Traffic - Type	CBR
Traffic - Packet size	600 bytes
AP - Queue Size	350 frames
AP - Queue drop policy	Drop tail
IEEE 802.11 - Operation mode	G
IEEE 802.11 - Beacon interval	100ms
IEEE 802.11 - Aggregation type	A-MSDU
Radio - Attenuation threshold	-110dBm
Radio - Maximum sending power	2.0mW
Radio - SNIR threshold	4dB
Radio - BER table	"per_table_80211g_Trivellato.dat"
Distance AP/STA	20m
Power while transmitting	2000mW
Power while receiving	1500mW
Power while idle	390mW
Power while sleeping	20mW
OPAMA α parameter	10
OPAMA β parameter	5

5.3.1 Assessing the Impact of the Number of Stations on the Energy Saving Mechanisms

This section presents the assessment concerning the impact of the number of stations on the power saving mechanisms under study. Subsection 5.3.1.1 discusses the results attained with each station receiving a CBR flow with a transmission rate of 50 packets per second, while Subsection 5.3.1.2 presents the results with a transmission rate of 100 packets per second.

5.3.1.1 Transmission Rate of 50 Packets per Second

This subsection presents the results regarding the impact of multiple stations on the energy saving mechanisms' performance. Each station receives one CBR flow from the server with a transmission rate of 50 packets/second, using a packet size of 600 bytes (Table 5.1).

The No-PSM and Legacy-PSM mechanisms do not have configurable parameters. U-APSD ready stations were configured to wake-up every 100 ms (time equal to the

5.3 Power Saving Mechanisms Performance within Multiple Stations Scenario

Beacon Interval) and OPAMA STA-MAD was defined as 100 ms. Such configurations allow a fair comparison among all the mechanisms. The other configurations are presented in Table 5.1.

Figure 5.2 depicts the average energy consumption (in Joule) per station for the studied energy saving mechanisms, namely No-PSM, Legacy-PSM, U-APSD and OPAMA. The x-axis represents the total number of simultaneous stations in the network.

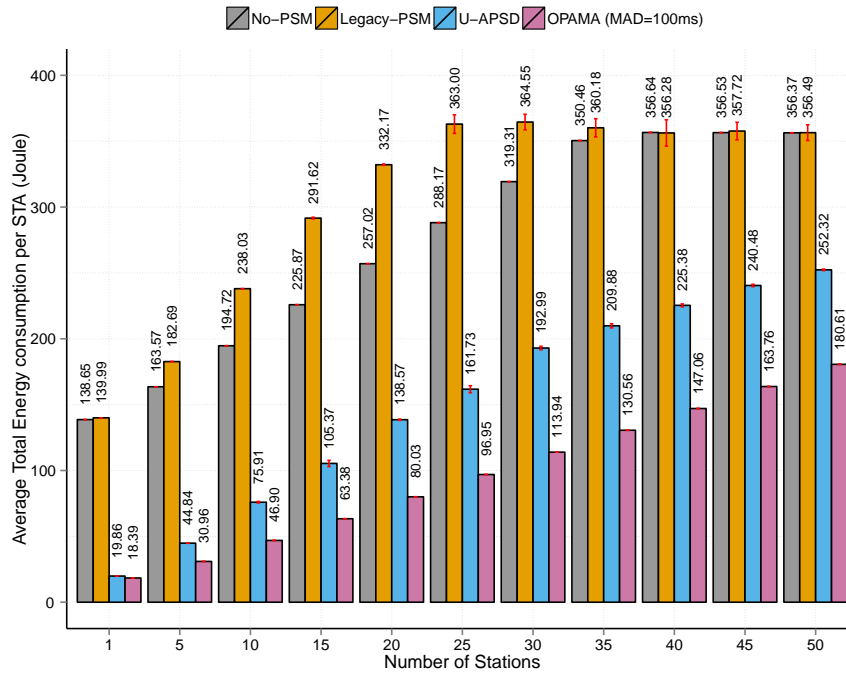

Figure 5.2: Average energy consumption per STA with transmission rate of 50 packets/sec.

The results obtained with OPAMA (STA-MAD = 100 ms) show that there is a direct relationship between the average energy consumption per STA and the number of stations in the network. One can observe that the average energy consumption per STA increases with the growth of the number of stations in the network. As an example, with 5 stations in the network, the average energy consumption per station is 30.96 Joule, while with 25 stations the energy consumption increases up to 96.95 Joule.

The energy consumption of U-APSD is always higher than OPAMA (STA-MAD = 100), although it has a similar behavior concerning the relation between the average energy consumption per STA and the total number of stations in the net-

5. Power Saving Mechanisms in Multiple Station Environments

work. By incorporating a frame aggregation mechanism, OPAMA algorithm reduces the Physical Layer Convergence Protocol (PLCP) frame overhead as well as the number of frame acknowledgments, allowing higher energy savings than U-APSD.

The average energy consumption per station of No-PSM and Legacy-PSM mechanisms' is always higher than OPAMA and U-APSD. Under these test conditions, Legacy-PSM ready stations use even more energy than No-PSM in all the scenarios. The reason for this behavior is twofold. First, the employed CBR traffic follows a constant pattern and does not create enough sleep opportunities for Legacy-PSM. Second, Legacy-PSM uses a polling mechanism where a STA must request each single pending frame by sending a PS-Poll frame back to the AP, leading to an increase of the collision probability and energy consumption.

Apart from the impact on the energy consumption, it is also important to assess the mechanisms influence in other relevant network metrics, namely packet loss and delay. Figure 5.3 illustrates the average packet loss rate per station. The total number of simultaneous stations in the network is depicted in the x-axis.

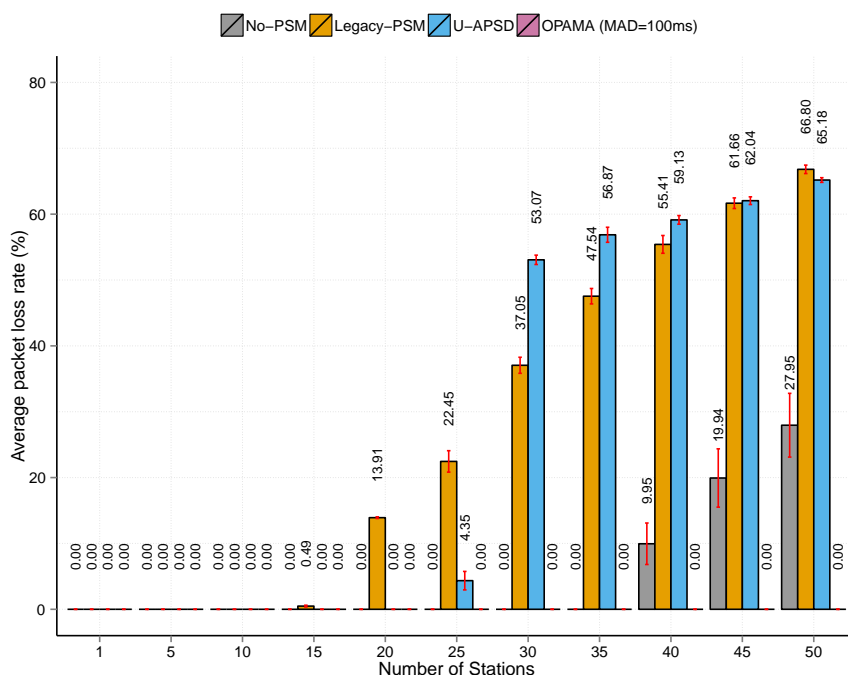

Figure 5.3: Average packet loss rate with transmission rate of 50 packets/sec.

With OPAMA (STA-MAD = 100 ms) there are no losses, as depicted. To better characterize this result, Figures 5.4a and 5.4b show the AP average and maximum queue

5.3 Power Saving Mechanisms Performance within Multiple Stations Scenario

lengths, respectively. By observing the maximum queue length for OPAMA, it is possible to see that the queue limit of 350 frames is never exceeded. With the U-APSD mechanism, packet loss rate increases with the total number of stations in the network. As illustrated in Figure 5.4b, U-APSD can only maintain the number of frames in the AP queue lower than the configured maximum limit with 25 or less stations. As a result, U-APSD starts to introduce considerable packet loss (around 53%) when the number of simultaneous stations in the network is greater or equal than 30 (Figure 5.3). This behavior of U-APSD is related with the saturation of the network capacity, leading the frames to stay longer in the AP queue and then to be discarded. OPAMA enhances the network capacity and avoids this behavior by employing frame aggregation.

The average packet loss rate of Legacy-PSM shows its limitations with more than 15 stations in the network. Again, the Legacy-PSM performance is directly related with the used polling mechanism. Comparing to OPAMA and U-APSD, Legacy-PSM uses considerable more signaling messages to retrieve the pending frames, which reduces the network capacity and results in faster saturation of the AP queue, as shown in Figure 5.4.

Although supporting more stations without losses than Legacy-PSM and U-APSD, the performance of No-PSM is also affected by the number of stations in the network. No-PSM does not introduce any packet loss with less than 40 stations in the network. With 40 or more stations, No-PSM has a similar behavior to Legacy-PSM and U-APSD.

OPAMA is the only mechanism able to support all the stations without losses, which reflects the importance of the aggregation in the algorithm design. This is achieved by the introduction of additional delay in the packets according to the STA-MAD defined by the end-users. In these scenarios STA-MAD is always equal to 100 ms.

Figure 5.5 depicts a Cumulative Distribution Function (CDF) of delay for all mechanisms under study. The obtained delay with No-PSM is always lower when compared to all the other mechanisms under study, unless for the scenarios where No-PSM introduces losses. In this case, OPAMA achieves lower delays than No-PSM. The main reason for this behavior is related with the employed drop tail discard policy at the AP queue. Whenever the network capacity is reached and the AP queue is full, the newly arrived frames are discarded. Therefore, the higher delays result from the frames staying longer in the AP queue.

Analogous to No-PSM, Legacy-PSM and U-APSD are affected by the same relationship between the packet loss rate and delay. However, Legacy-PSM ready sta-

5. Power Saving Mechanisms in Multiple Station Environments

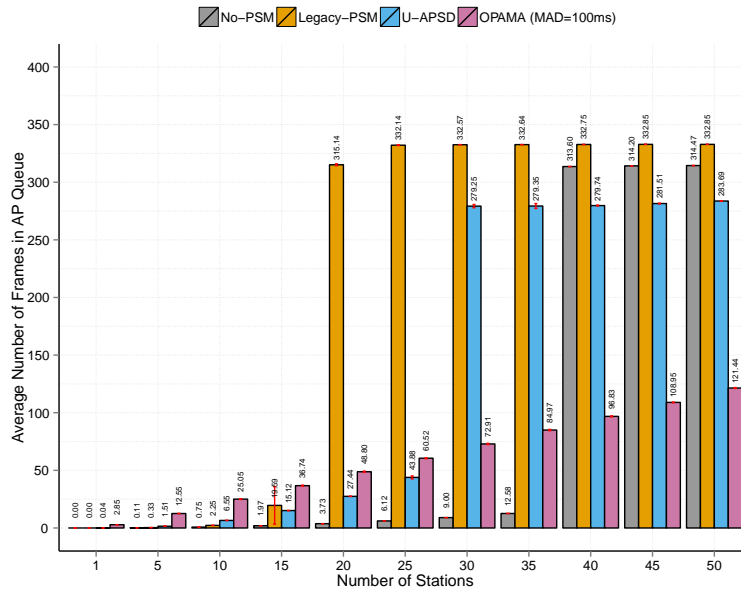

(a) Average AP queue length

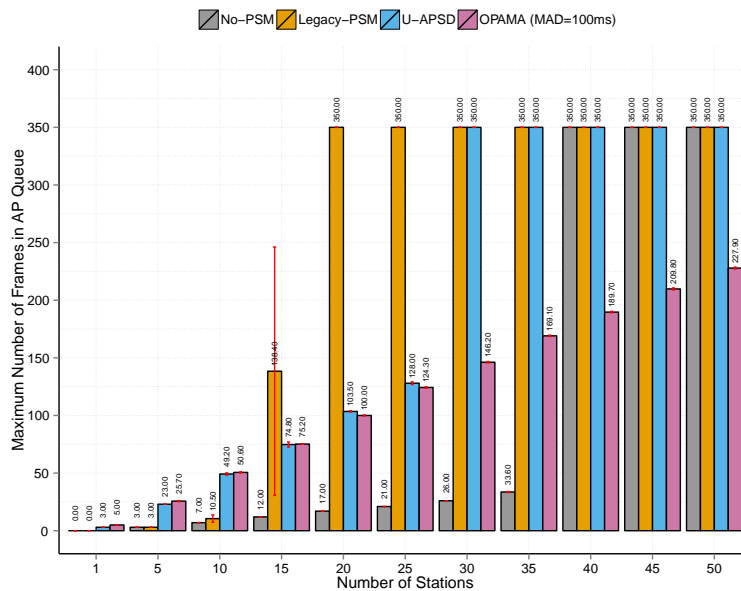

(b) Maximum AP queue length

Figure 5.4: Access Point queue statistics for all mechanisms with transmission rate of 50 packets/sec.

5.3 Power Saving Mechanisms Performance within Multiple Stations Scenario

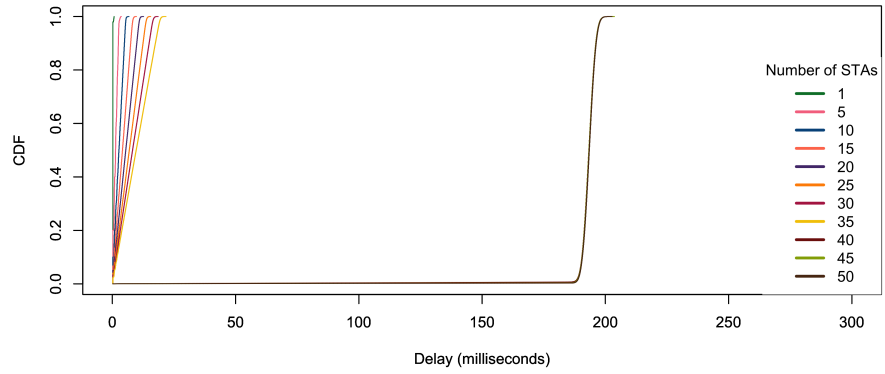

(a) No-PSM

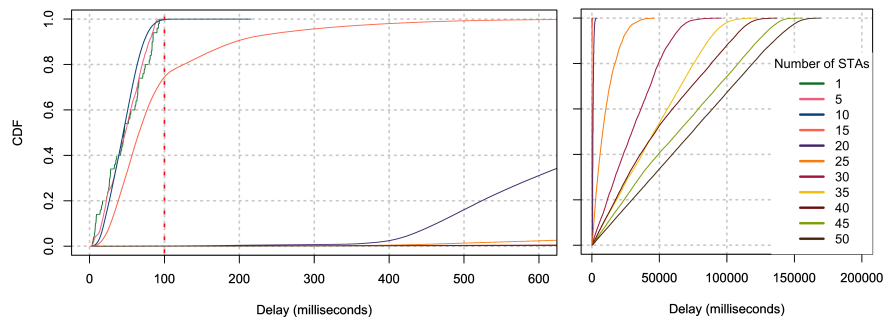

(b) Legacy-PSM

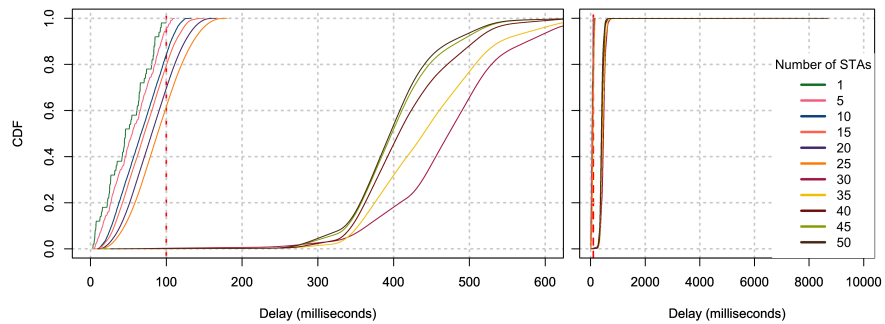

(c) UAPSD

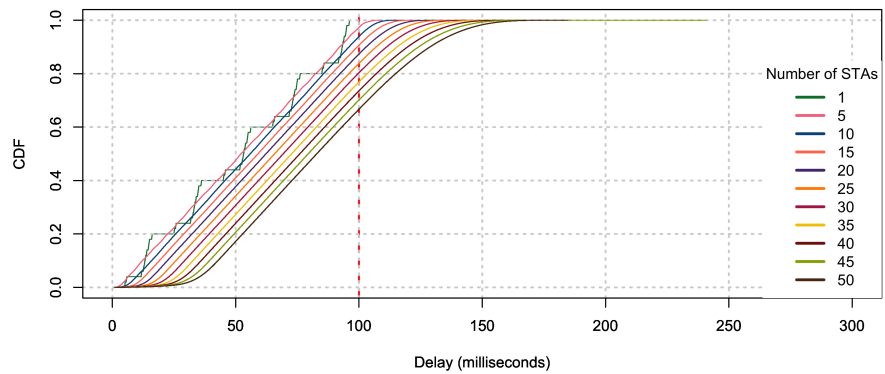

(d) OPAMA (MAD=100 ms)

Figure 5.5: Delay CDF for all algorithms with transmission rate equal to 50 packets/sec.

5. Power Saving Mechanisms in Multiple Station Environments

tions always show higher delays. As an example, with 50 simultaneous stations in the network, the measured delays with Legacy-PSM exceeds 150 seconds, while with U-APSD delays are always bellow 9 seconds.

The number of stations in the network also has a direct impact on the OPAMA measured delays. As OPAMA was configured with STA-MAD = 100 ms, the maximum delay tolerable by each STA is 100 ms. Nonetheless, although OPAMA does not introduce packet loss and has the best energy performance, it is not always able to guarantee the 100 ms maximum delay for scenarios with multiple stations. One can observe that there is a clear relationship between the delay and the number of stations in the network. This is mainly related with the time needed to serve multiple stations within the same *Beacon Interval*, leading to extra delays and additional energy consumption, as each station must be in active state for longer. As an example, OPAMA with 1 station in the network has a maximum delay of around 96.18 ms, while in the presence of 50 stations the maximum delay reaches 184.78 ms.

In short, the performance of OPAMA with STA-MAD = 100 ms is directly affected by the number of stations in the network, with clear impact on both average energy consumption per STA and delay. Nevertheless, OPAMA shows higher energy efficiency capabilities than all the studied mechanisms, without introducing packet loss.

Therefore, with a transmission rate of 50 packets/sec, the energy / performance tradeoff achieved by OPAMA showed clear benefits of employing this proposal within multi-station environments.

5.3.1.2 Transmission Rate of 100 Packets per Second

This subsection discusses the results concerning the impact of multiple stations on the energy saving mechanisms, with a transmission rate of 100 packets/second. All the other configurations remain as in the previous subsection.

The average energy consumption, in Joule, for the mechanisms under study is illustrated in Figure 5.6. The total number of stations present in the network is depicted in the x-axis.

Similarly to the scenarios with a transmission rate of 50 packets/sec, OPAMA energy performance is also influenced by the number of STAs in the network. Apart from the impact concerning the number of stations, the energy performance is influenced by the higher transmission rate used. As it can be observed, the average energy consumption per STA when using OPAMA with a transmission rate of 100 packets/sec is always higher compared to the scenarios with a transmission rate of 50 packets/sec.

5.3 Power Saving Mechanisms Performance within Multiple Stations Scenario

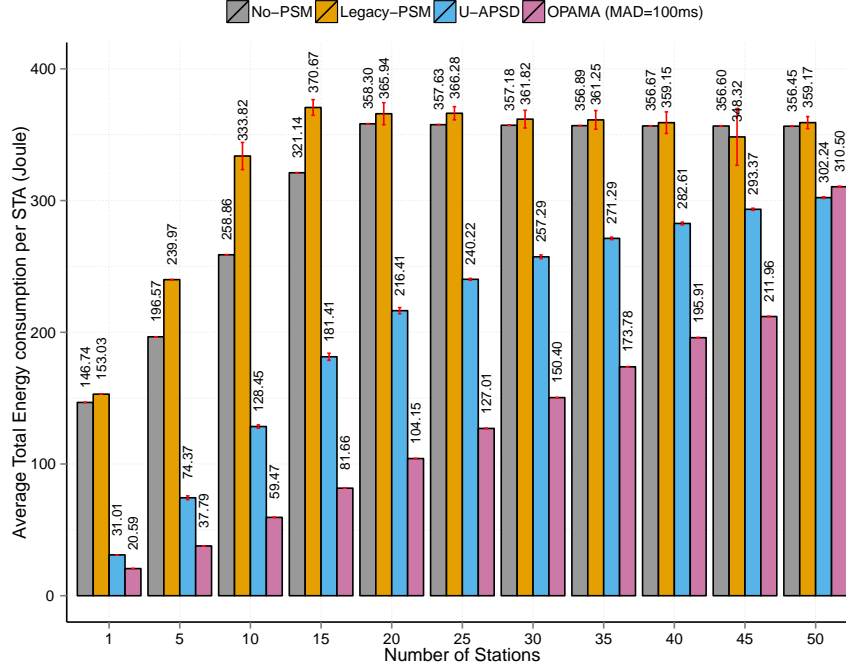

Figure 5.6: Average energy consumption per STA with transmission rate of 100 packets/sec.

For instance, with 25 stations the average energy consumption per STA receiving 50 packets/sec is 96.95 Joule, while with the rate of 100 packets/sec is 127.01 Joule.

The energy performance of U-APSD also follows the same pattern as in the previous scenarios with lower transmission rate. However, the impact of the transmission rate on the U-APSD performance is more noticeable than in OPAMA, which is clearly visible when analyzing the absolute values of the average energy consumption per STA. As an example, with 5 stations in the network and with a transmission rate of 50 packets/sec, U-APSD uses around 45% more energy than OPAMA. With a transmission rate of 100 packets/sec such gap increases to 97%.

Legacy-PSM and No-PSM have similar energy performance compared to the previous scenario. The energy consumption is measured in the end-user equipment, which means that only packets arriving at the end-user equipment will have impact on the energy consumption. Therefore, with these mechanisms, the average energy consumption does not increase considerably with this higher transmission rate as many packets will never be delivered.

Figure 5.7 depicts the average packet loss rate per station, with the total number

5. Power Saving Mechanisms in Multiple Station Environments

of simultaneous stations in the network represented in the x-axis. Unlike what was

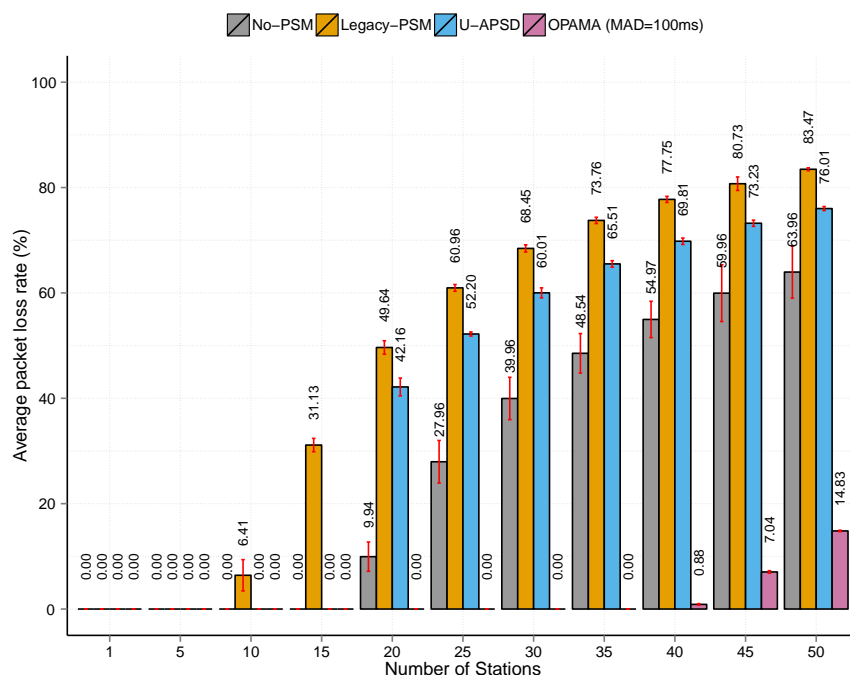

Figure 5.7: Average packet loss rate with transmission rate of 100 packets/sec.

observed with a transmission rate of 50 packets/sec, in this scenario there is packet loss with OPAMA (STA-MAD = 100 ms). Employing a transmission rate of 100 packets/sec, OPAMA is not able to always keep the AP queue limit below the configured maximum (i.e., 350 frames). Figure 5.8 depicts the maximum AP queue length for the various mechanisms under study. One can observe that OPAMA (STA-MAD = 100 ms) reaches the maximum queue size of 350 frames with 40 STAs in the network.

The packet loss rate analysis shows that the other mechanisms are affected by the higher transmission rates, while the impact regarding the number of stations in the network is also still visible. U-APSD has a similar behavior to OPAMA with less than 20 stations in the network, as shown by the lack of packet loss and maximum number of frames in the AP queue in Figures 5.7 and 5.8, respectively.

Concerning the packet loss measured for No-PSM and Legacy-PSM mechanisms, it also follows the same pattern as with the transmission rate of 50 packets/sec. It is interesting to notice that No-PSM has a packet loss rate of around 10% with 20 stations in the network using a transmission rate of 100 packets/sec, while with a transmission rate of 50 packets/sec an identical loss rate is only reached with 40 STAs

5.3 Power Saving Mechanisms Performance within Multiple Stations Scenario

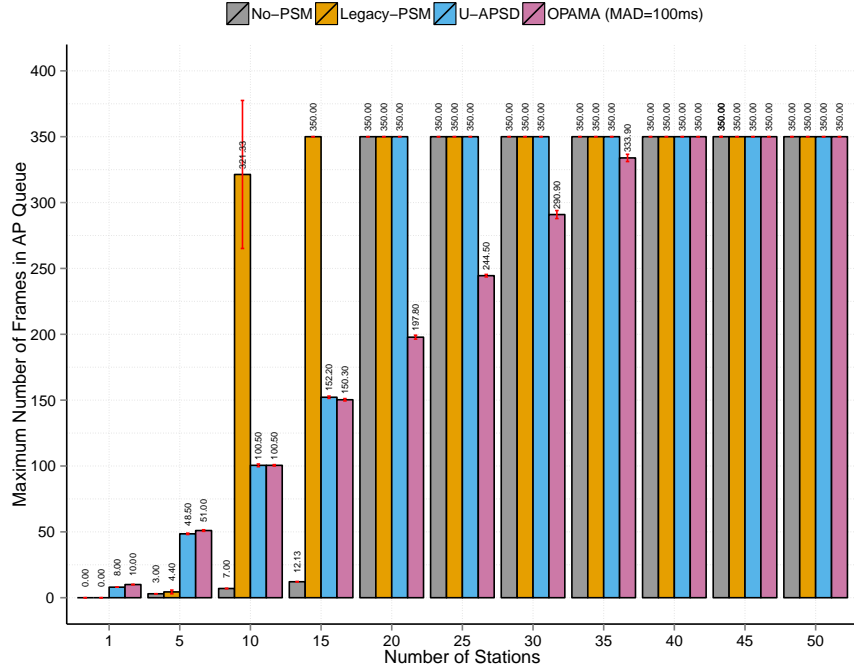

Figure 5.8: Maximum AP queue length with transmission rate of 100 packets/sec.

in the network. Such results clearly highlight the impact of the traffic pattern and number of stations in the network on the overall mechanisms performance.

Figure 5.9 illustrates the delay CDF for OPAMA with transmission rate of 100 packets/sec. The delays for the remaining mechanisms are not depicted as the behavior is very similar to Figure 5.5, where the delay CDF with a transmission rate of 50 packets/sec is shown.

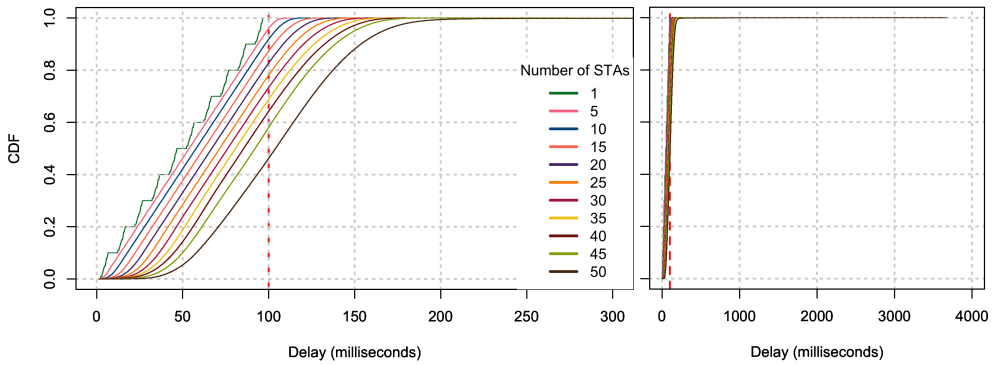

Figure 5.9: Delay CDF for OPAMA with transmission rate of 100 packets/sec.

5. Power Saving Mechanisms in Multiple Station Environments

When compared with the scenarios using transmission rate of 50 packets/sec, the OPAMA maximum delays using a transmission rate of 100 packets/sec are only slightly higher. Nevertheless, there is a direct relation between the number of stations in the network and measured delays. As in the lower rate scenario, OPAMA is only able to keep the delay within the defined bounds of 100 ms for a single station scenario. For the scenarios where the AP queue maximum queue length is reached (i.e., with 40 or more STAs in the network), OPAMA shows maximum delays of around 2 seconds. Notwithstanding, one should note that OPAMA performance is still better than all other mechanisms for all the scenarios tested.

Until now, OPAMA was only tested with a STA-MAD = 100 ms, which allows a fair comparison with the other mechanisms, as explained in the begin of Subsection 5.3.1.1. The following subsection will analyze the defined Station Maximum Allowed Delay (STA-MAD) in OPAMA.

5.3.2 STA-MAD Impact on OPAMA Performance with Multiple Stations

This section discusses the impact of the distinct values of Station Maximum Allowed Delay (STA-MAD) within multiple STA scenarios. The configuration employed was the same as in the assessment performed in Subsection 5.3.1.1, where each STA is receiving a CBR flow from the server with a rate of 50 packets/sec. As the goal is to study the OPAMA behavior with distinct STA-MADs, the AP queue maximum size was defined as 2000 frames. In contrast with previous scenarios, OPAMA with STA-MAD longer than 100 ms needs more buffering space in the queue as the frames stay there longer.

Figure 5.10 shows the average energy consumption per STA using the distinct STA-MAD values configured by the end-user. The x-axis represents the total number of simultaneous stations in the network.

OPAMA energy consumption is directly related to the number of stations in the network for all the STA-MAD values studied. Nevertheless, one can see that the average energy consumption per STA with smaller STA-MADs is considerable higher.

With STA-MAD = 100 ms and STA-MAD = 150 ms, OPAMA shows a similar energy consumption for all the scenarios. As the OPAMA algorithm is executed in every *Beacon Interval* (configured as 100 ms), the sleep opportunities generated by both STA-MADs are similar. Despite this, with 50 simultaneous stations in the network, STA-MAD = 150 ms already results in some energy savings.

The impact of STA-MAD on the energy consumption is clearly visible in Figure

5.3 Power Saving Mechanisms Performance within Multiple Stations Scenario

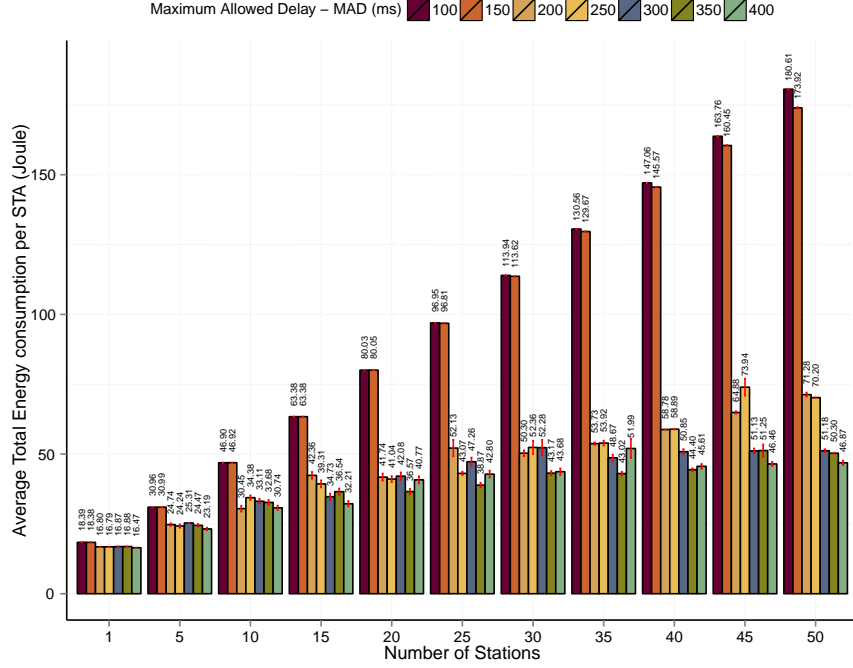

Figure 5.10: Average energy consumption per STA of OPAMA with distinct STA-MADs (transmission rate of 50 packets/sec).

5.10, with the end-users that support higher delays achieving considerable energy savings. For instance, with 25 stations in the network, the average energy consumption employing a STA-MAD of 100 ms is 96.95 Joule, while the stations supporting delays up to 200 ms use on average 50.30 Joule (representing around 48% of energy saved).

Concerning the relationship between the defined STA-MAD and the energy consumption, the obtained results show some cases where higher STA-MAD is not reflected in additional energy savings. The small energy gaps in these and similar situations are mainly explained by the total number of stations and average time needed to serve each one within a *Beacon Interval*. Even though the traffic pattern is similar for all the stations, collisions and retransmissions at MAC layer might occur, leading all the stations being served in that *Beacon Interval* to consume more energy. Such energy peaks are also illustrated in the confidence interval limits depicted by the lines on the top of each bar. As an example, with 25 stations present in the network, end-users with STA-MAD = 350 ms use slightly less energy on average than the ones supporting only STA-MAD = 400 ms.

Since there are no packet losses for all the scenarios tested, such information will

5. Power Saving Mechanisms in Multiple Station Environments

not be plotted. Figure 5.11 depicts a *boxplot* showing the end-to-end delay (in milliseconds) obtained for all the packets received.

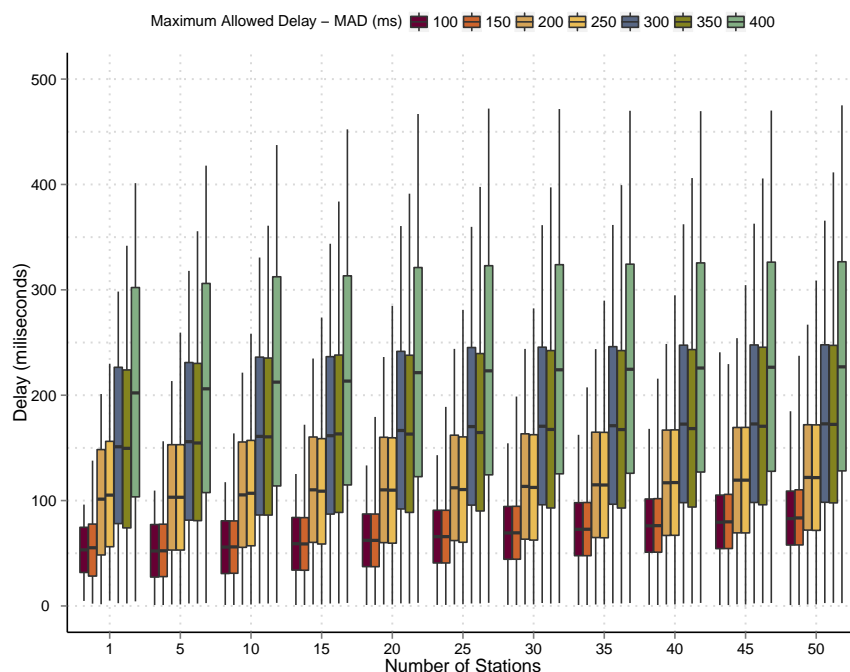

Figure 5.11: Delay of OPAMA with distinct STA-MADs (transmission rate equal to 50 packets/sec).

The delay results show a correlation between the STA-MAD and the maximum delays attained. As expected, the STA-MAD increases the packet buffering time in the AP queue and leads to higher delays. OPAMA is only able to guarantee the defined STA-MAD for the single station scenario, independently of the extra delay supported by the end-user. Nevertheless, it is possible to observe that 75% (third quartile) of the delivered packets have a delay lower than the configured STA-MAD.

5.3.3 Evaluating Energy Consumption and Video Quality with Multiple Stations

This subsection discusses the assessment of video energy consumption and quality with multiple stations.

The evaluation methodology follows the procedures already presented in Section 4.3. This assessment employs the “*Elephants Dream*” raw sequence [Blender Foundation / Netherlands Media Art Institute, 2015][Van der Auwera et al., 2008], encoded

5.3 Power Saving Mechanisms Performance within Multiple Stations Scenario

with H.264/MPEG-4 AVC codec using a Variable Bit Rate, and with a resolution of 352x288. As in all other multiple station tests, the video will be played for 300 seconds, containing 7200 frames. The remaining simulation parameters were presented in Section 5.2.

Table 5.2 depicts the most relevant parameters and QoE metrics for the video, compressed using a Constant Rate Factor (CRF) (also known as Quality Constant method) equal to 22, as it represents a very good quality for the end-users, as showed by the obtained SSIM=0.98.

Table 5.2: Parameters of compressed video.

Name	CRF	Avg. Bitrate	Reference PSNR	Reference SSIM
Elephants Dreams	22	537 kb/s	42.11±5.51	0.98±0.01

The video evaluation was performed with the hybrid video quality assessment methodology defined in Section 4.3.1, while the other metrics were obtained directly in the OMNeT++ simulator.

The compressed video bitrate is around 537 kb/s, which is slightly higher than the bitrate achieved with the transmission rate of 100 packets per seconds with 600 bytes payload (i.e., 480 kb/s). Therefore, considering the existing packet loss rate with more than 25 stations in the network in the scenario of 100 packets per seconds, the following analysis will only include tests with 1, 5, 10, 15, 20 and 25 stations. Analogous to the synthetic traffic tests, each STA receives a video flow from the server.

Figure 5.12 depicts the average energy consumption, in Joule, per STA using the power saving mechanisms No-PSM, Legacy-PSM, U-APSD and OPAMA (MAD = 100 ms). The distinct number of stations is represented in the x-axis.

As in the scenarios with synthetic traffic, OPAMA (MAD = 100 ms) always shows a lower energy consumption when compared with the other mechanisms. The impact of the number of stations in the network on the average energy consumption per STA is clearly visible.

U-APSD energy consumption is always lower than No-PSM and Legacy-PSM, but slightly higher than OPAMA (MAD = 100 ms). Legacy-PSM shows the same behavior as in the previous scenarios, depicting a higher average energy consumption per STA than No-PSM. Such effect has already been discussed in the previous sections.

Besides the energy consumption assessment, it is important to evaluate the QoE perceived by the end-users when receiving the video. The QoE assessment is per-

5. Power Saving Mechanisms in Multiple Station Environments

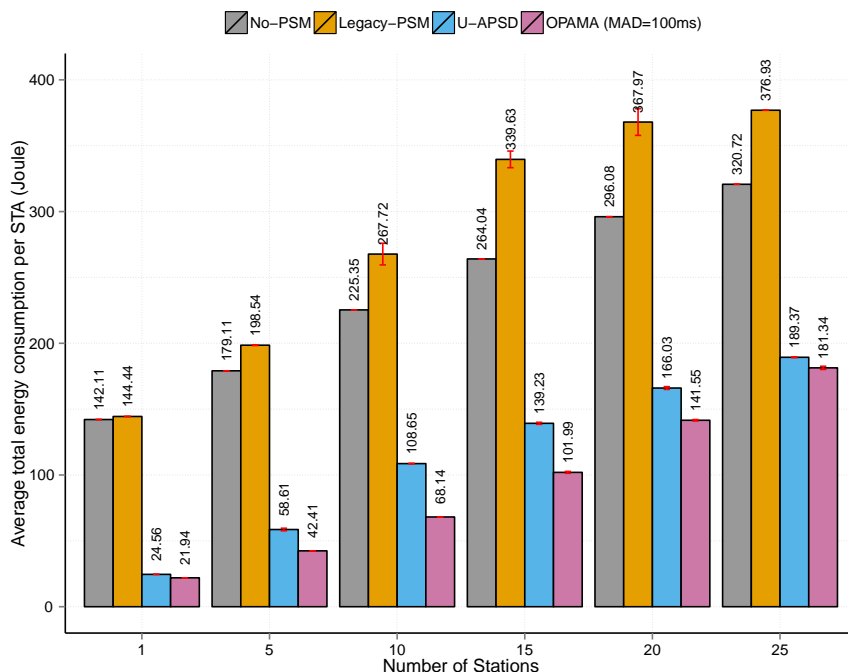

Figure 5.12: Average energy consumption per STA receiving Elephants Dreams video.

formed through the SSIM metric, as illustrated in Figure 5.13. The SSIM shows the video similarity compared with the corresponding lossless sequence, where a value of 1 represents complete similarity.

As it can be observed, the attained SSIM is directly affected by the number of stations in the network. Despite the energy consumption pattern previously discussed, with a single station in the network all the mechanisms guarantee a very good quality perception to the end-users (SSIM = 0.98).

OPAMA (MAD = 100 ms) is able to keep the end-users' perceived quality within an acceptable level for all the scenarios. Even with 25 stations in the network, OPAMA still achieves an acceptable quality level, as shown by the average SSIM = 0.86.

The quality obtained when employing Legacy-PSM and U-APSD shows the limitations of both mechanisms to achieve an acceptable quality with multiple stations in the network. For instance, with 15 or more stations in the network the average SSIM obtained is around 0.40, which represents a very bad correlation with the original sequence.

With No-PSM, the attained quality is always acceptable, but with a considerable drop with larger number of stations in the network. Such quality drop is explained by

5.3 Power Saving Mechanisms Performance within Multiple Stations Scenario

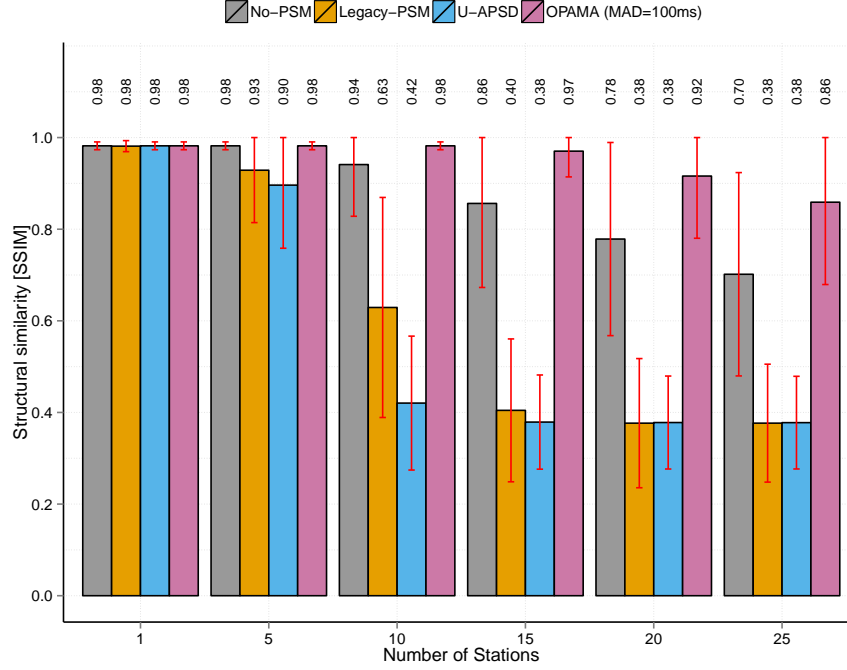

Figure 5.13: Average SSIM per STA receiving Elephants Dreams video.

the packet loss rate, depicted in Figure 5.14.

As previously shown when analyzing the results with synthetic traffic, there is a direct relationship between the number of stations in the network and the packet loss rate. Unlike the other mechanisms, OPAMA shows a packet loss rate almost negligible for all the scenarios. Again, such packet loss behavior can be explained by the lower network capacity achieved by the other power saving mechanisms, leading the AP queue to become full and frames to be discarded. As an example, with 25 STAs in the network OPAMA packet loss is 0.25% and the average SSIM is equal to 0.86.

Figure 5.15 depicts a CDF of delay for OPAMA (MAD = 100 ms). The dashed line for the delay at 200 ms represents the configured playout buffer parameter during the tests.

One can observe that OPAMA can only guarantee a delay lower than the playout buffer, for all the packets, with less than 10 stations in the network. The video frames arriving with higher delays will be discarded, as they cannot be played anymore. Therefore, the delay increase, together with existing packet loss, leads to a slightly drop in the end-users perceived quality when employing OPAMA to receive this video sequence (Figure 5.13) compared to the scenario where one single station is

5. Power Saving Mechanisms in Multiple Station Environments

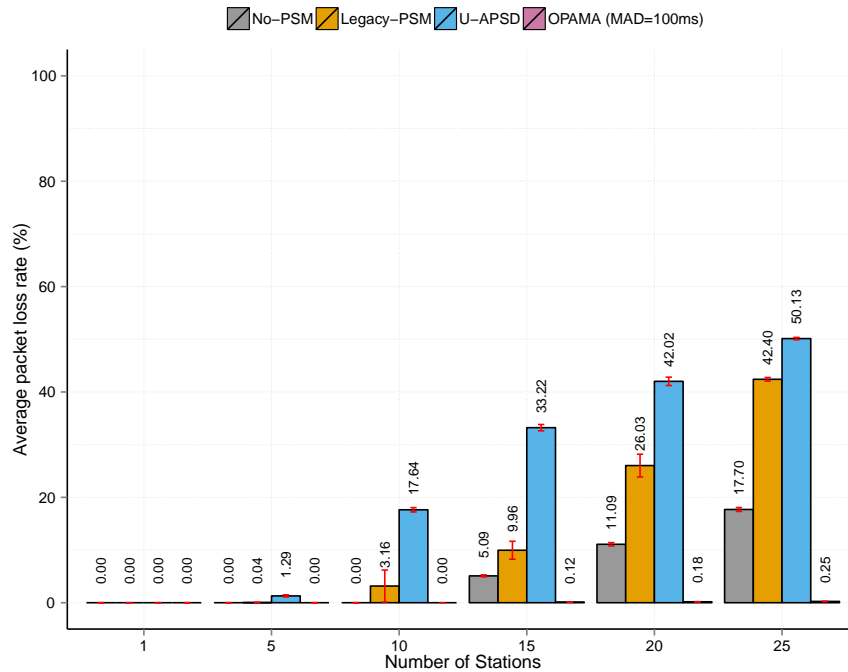

Figure 5.14: Average packet loss rate per STA receiving Elephants Dreams video.

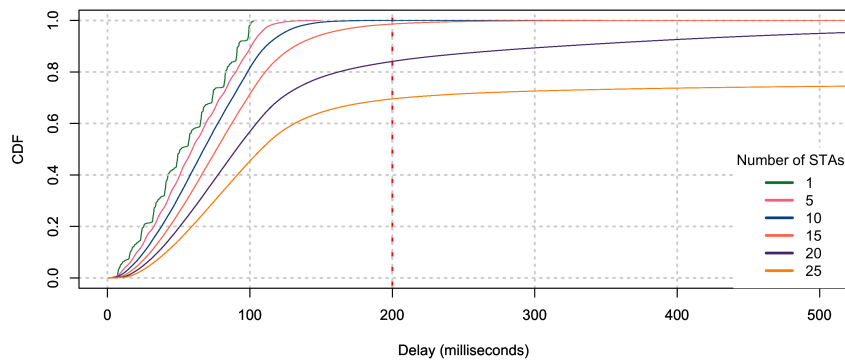

Figure 5.15: OPAMA delay CDF when receiving Elephants Dreams video.

presented in the network.

These results highlight the need to analyze the attained QoE, instead of solely assessing the network level parameters. In addition, the QoE allows the application of specific parameters to be included in the assessment (e.g., video decoding correlation between frames).

5.3 Power Saving Mechanisms Performance within Multiple Stations Scenario

Apart from analyzing the OPAMA performance when compared with the standard power saving mechanisms, the Station Maximum Allowed Delay (STA-MAD) impact on both energy consumption and QoE perceived by the end-users should also be investigated.

Figure 5.16 depicts the average energy consumption per station using the different Station Maximum Allowed Delay values when receiving the video sequence. The x-axis illustrates the total number of simultaneous stations in the network.

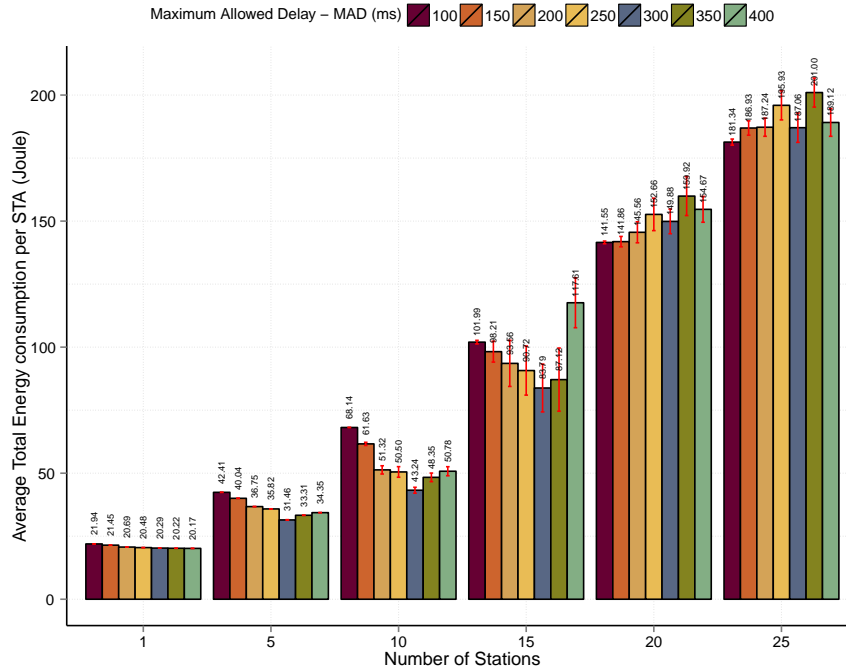

Figure 5.16: Average energy consumption per STA of OPAMA with distinct STA-MADs receiving video.

The configured STA-MAD has direct influence on the energy consumption. With a single station in the network, the energy consumption decreases while the STA-MAD increases, as expected. A similar behavior is observed with less than 15 stations in the network.

With more than 15 STAs, the higher STA-MAD values do not allow any energy to be saved by the stations. When employing a higher STA-MAD there will be more data to be transmitted at the same time to each STA, which can result in higher waiting periods in active state for other stations waiting to be served by the AP. As a result, the energy consumption uncertainty is higher when compared with other scenarios,

5. Power Saving Mechanisms in Multiple Station Environments

illustrated by the confidence interval on the top of each bar.

Figure 5.17 depicts the SSIM assessment for the distinct Station Maximum Allowed Delay when receiving the video.

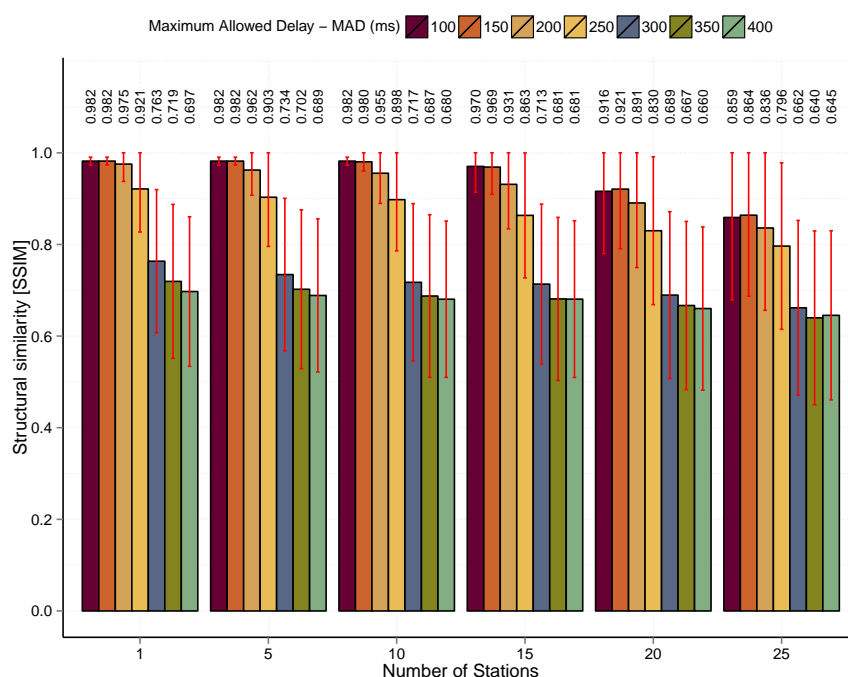

Figure 5.17: Average SSIM per STA of OPAMA with distinct STA-MADs receiving video.

The lower STA-MADs are always able to guarantee the best QoE for the end-users. It is also possible to establish a relationship between the STA-MADs and the attained quality, as the attained quality decreases when the STA-MAD increases. When analyzing the scenarios with a STA-MAD = 100 ms it is possible to observe a direct impact of the number of stations on the observed quality, as with a single station the average SSIM for this STA-MAD is 0.982, while with 25 stations present the SSIM decreases up to 0.859.

In short, as in other scenarios, one can observe that the higher number of STAs in the network has a negative impact on the QoE perceived by the end-users. The next section will address this issue and propose a solution to address it.

5.4 Enhancing Power Saving Mechanisms for Multiple Station Environments

This section discusses the energy overhead problems raised by the usage of multiple stations, which has been identified in the previous sections.

5.4.1 Problem Statement

The employment of the most popular power saving mechanisms and OPAMA has shown clear limitations in the presence of multiple stations. When compared with the other mechanisms, OPAMA reveals stronger capabilities to establish a proper energy / quality trade-off. Nevertheless, OPAMA results show a clear impact of the number of stations on the average energy consumption per STA. Figure 5.18 depicts the OPAMA operation with multiple stations in the network, during a certain beacon interval.

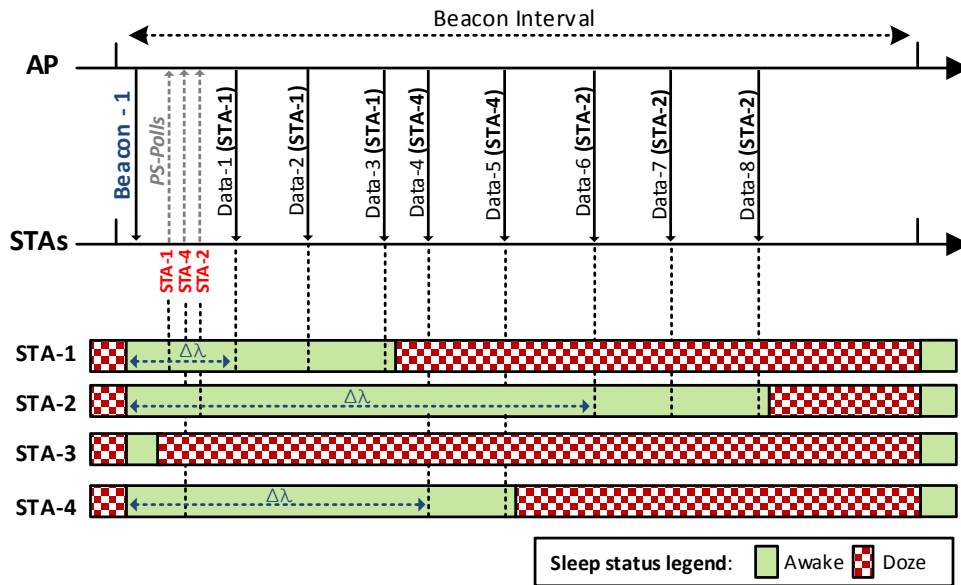

Figure 5.18: OPAMA operation with multiple stations.

The Access Point (AP) broadcasts *Beacon-1* containing TIM information, which is received by the 4 associated stations, namely STA-1, STA-2, STA-3 and STA-4. *Beacon-1* TIM indicates pending traffic for STA-1, STA-2 and STA-4, while STA-3 does not have any buffered data to be received. As a result, STA-3 goes back into sleep state. The remaining stations must poll the AP to fetch the pending data.

5. Power Saving Mechanisms in Multiple Station Environments

After processing the TIM information in *Beacon-1*, each station sends a *PS-Poll* message to the AP asking for the pending data. Then, the STAs must stay awake while the *MoreData* flag is set. As only one STA can be served at a time, the other stations with pending data are forced to be awake without receiving data.

In this example, STA-1 is the first to poll the AP. As a result, using a first-come first-served approach, the AP will deliver the buffered data to STA-1, followed by STA-4 and STA-2. STA-1 receives the first pending frame, *Data-1*, immediately after polling the AP. After the reception of *Data-3*, where the *MoreData* flag is not set, STA-1 goes back into sleep until the next beacon.

Unlike STA-1, STA-4 is not served immediately after polling the AP. As it can be observed, STA-4 stays unnecessarily in awake state between the polling action and the reception of the first data frame (*Data-4*). Similarly, STA-2 stays in awake state without receiving any data until the STA-4 data reception is not completed.

Let $\Delta\lambda$ be a time interval where a STA stays unnecessarily awake without receiving any data from the AP. One can observe that, in this example, $\Delta\lambda$ for STA-1 is smaller than for STA-2 and STA-4. The $\Delta\lambda$ intervals duration increases with the number of stations in the network, leading to a superior average energy consumption as depicted in the previous scenarios.

The reduction of the average energy consumption per STA in a scenario with multiple stations can be done by minimizing the total duration of all $\Delta\lambda$ intervals. The following section will address this issue by proposing the Enhanced Power Saving Mechanism for Multiple station Environments, called EPS4ME.

5.4.2 Enhanced Power Saving Mechanism for Multiple Station Environments (EPS4ME)

This subsection presents the Enhanced Power Saving Mechanism for Multiple station Environments (EPS4ME), which can be combined with OPAMA. This proposal assumes that OPAMA is being used in the network, and will further be referred as OPAMA-EPS4ME.

When using OPAMA, if the AP has packets buffered to a certain STA, it will send a notification via the TIM field within the *Beacon* frame. As shown before, the main problem with this approach is when multiple stations have pending data to be received in the same beacon interval. Moreover, the stations with buffered data perform the polling to the AP immediately after receiving the beacon, as depicted in Figure 5.18. Each STA is informed by the AP that buffered data exists if its corresponding bit

5.4 Enhancing Power Saving Mechanisms for Multiple Station Environments

in the Partial Virtual Bitmap (PVB) field of the TIM is set. Nevertheless, all the stations receive the complete PVB information, allowing each one to be aware of the number of stations that will subsequently poll the AP.

By employing a hamming weight [Arno and Wheeler, 1993] technique to the PVB bitmap, it is possible that each station knows exactly the total number of stations with pending data in a certain beacon interval. As each STA is identified by the relative position in the bitmap, it is also possible to compute the number of stations with pending data before/after the current STA.

EPS4ME introduces a polling delay to each station according to its relative position in the PVB bitmap. For each STA, the EPS4ME extra delay can be expressed as $d_{EPS4ME}(STA_n) = PVBPos(STA_n) * (BI / NumSTAPendData(PVB))$. In this equation $PVBPos(STA_n)$ is the function that computes the STA_n relative position, from 0 to 2007, in the PVB. BI represents the configured beacon interval, while the $NumSTAPendData(PVB)$ function returns the total number of stations with buffered data. After beacon reception, all stations but the first go back into sleep until the calculated d_{EPS4ME} is reached. Thereafter, they wake-up and perform the polling to the AP.

Figure 5.19 illustrates the OPAMA-EPS4ME proposal within multiple stations in the network. Figure 5.18 depicted the same scenario using only OPAMA.

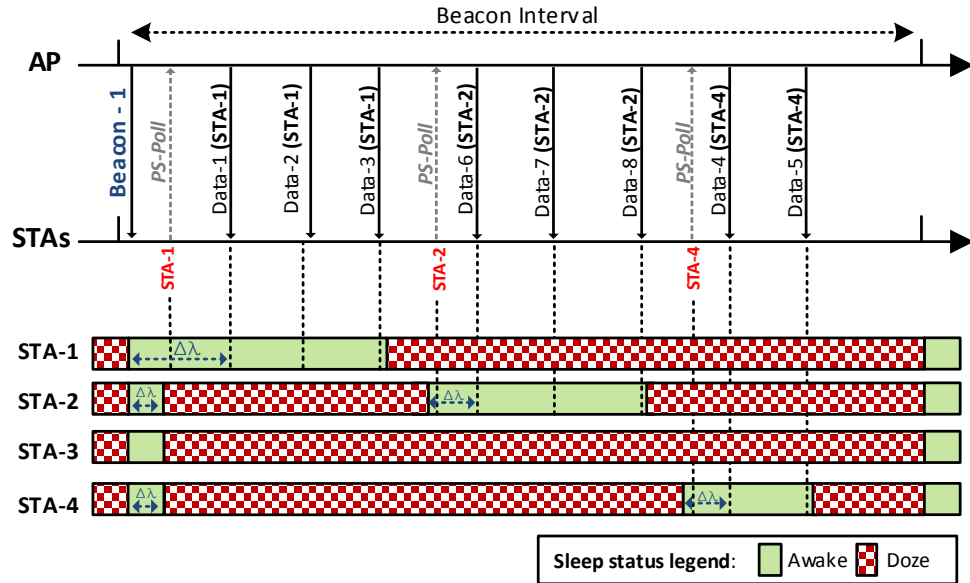

Figure 5.19: OPAMA-EPS4ME operation with multiple stations.

5. Power Saving Mechanisms in Multiple Station Environments

As in the scenario shown in Figure 5.18, the PVB contained in *Beacon-1* gives indication that STA-1, STA-2, STA-4 have pending traffic. STA-3 will just go back into sleep as it does not have any pending data according to the OPAMA algorithm. Unlike with the original OPAMA, when employing EPS4ME mechanism, the stations will poll the AP according to $d_{EPS4ME}(STA_n)$, as explained.

When using OPAMA-EPS4ME, the stations are served according to their identification in the AP. As a result, STA_n will receive the data always before STA_{n+1} . Such approach will cause a starvation for the stations with higher IDs, which should be addressed in future work. One can observe that the attained $\Delta\lambda$ for the various STAs using OPAMA-EPS4ME is always smaller when compared with the original OPAMA (Figure 5.18). For instance, with original OPAMA, STA-4 is in awake state from the beacon reception until the delivery of the last data frame, *Data-5*. Using OPAMA-EPS4ME allows STA-4 to go back into doze state after the beacon processing and to wake-up later to poll the AP.

The following section will discuss the performance of OPAMA-EPS4ME, when compared with the original OPAMA.

5.4.3 Results

This section presents the results for OPAMA-EPS4ME using the same scenarios already discussed before.

Figure 5.20 illustrates the OPAMA-EPS4ME average energy consumption per STA, when compared with the original OPAMA, for the two distinct CBR scenarios in study. Unlike with the original OPAMA, the impact of the number of stations in the network when using OPAMA-EPS4ME is almost negligible. With one station in the network both the original OPAMA and the OPAMA-EPS4ME consume roughly the same energy, as expected.

Considering the scenario with a transmission rate of 100 packets/second and 25 stations in the network, the average energy consumption per STA with the original OPAMA is 127.01 Joule, while the OPAMA-EPS4ME uses only 24.55 Joule. In this scenario, the employment of OPAMA-EPS4ME allows energy savings up to 80.67%. As it can be observed, OPAMA-EPS4ME achieves considerable energy saving for both transmission rates in all scenarios with more than one station.

Despite the fact that OPAMA-EPS4ME shows clear benefits when compared with original OPAMA concerning energy consumption, the number of stations and the transmission rate have impact on the average energy consumption. One can observe

5.4 Enhancing Power Saving Mechanisms for Multiple Station Environments

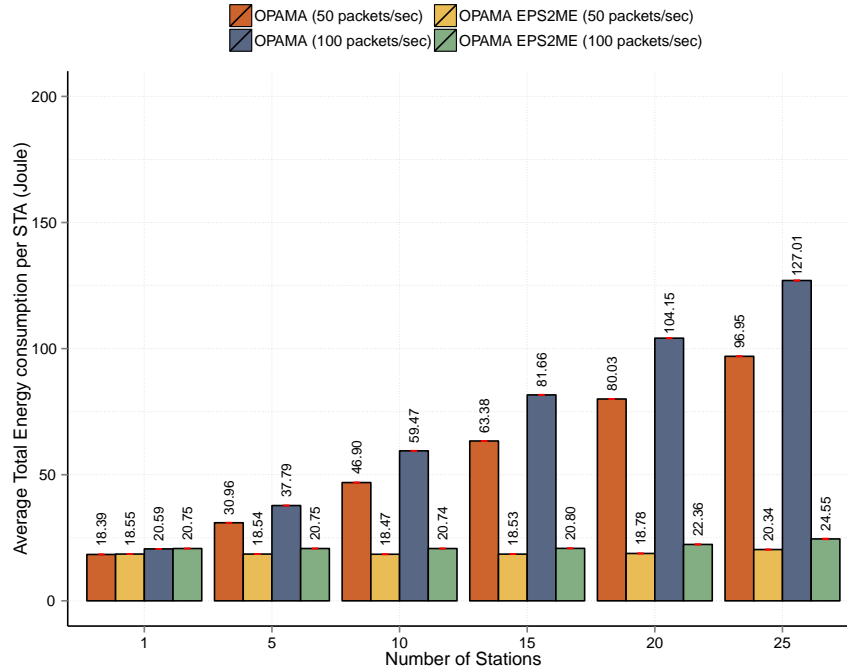

Figure 5.20: OPAMA average energy consumption per STA with different CBR transmission rates and mechanisms.

that with less than 25 stations in the network the average energy consumption for all the scenarios is similar to the one achieved with a single station in the network. As an example, with a transmission rate of 50 packets/second, the average energy consumption increases from 20.75 Joule with single STA to 24.55 Joule with 25 STAs.

The impact of OPAMA-EPS4ME in the delay is illustrated in Figure 5.21, where the delay CDFs for OPAMA and OPAMA-EPS4ME are depicted.

OPAMA-EPS4ME increases the overall packet delay, achieving delays of around 200 ms, while the maximum delay with original OPAMA never exceeds 160 ms. Nonetheless, when compared with OPAMA, OPAMA-EPS4ME guarantees lower delays for more than 90% of the packets. As there are no packet losses for all the scenarios, such metric is not plotted.

Similar to the previous section, the performance of OPAMA-EPS4ME receiving video was also tested. Figure 5.22 shows the average energy consumption per STA when receiving the “*Elephants Dream*” sequence.

OPAMA-EPS4ME performance is affected by the number of STAs present in the network. As an example, when compared with OPAMA, in a network scenario with

5. Power Saving Mechanisms in Multiple Station Environments

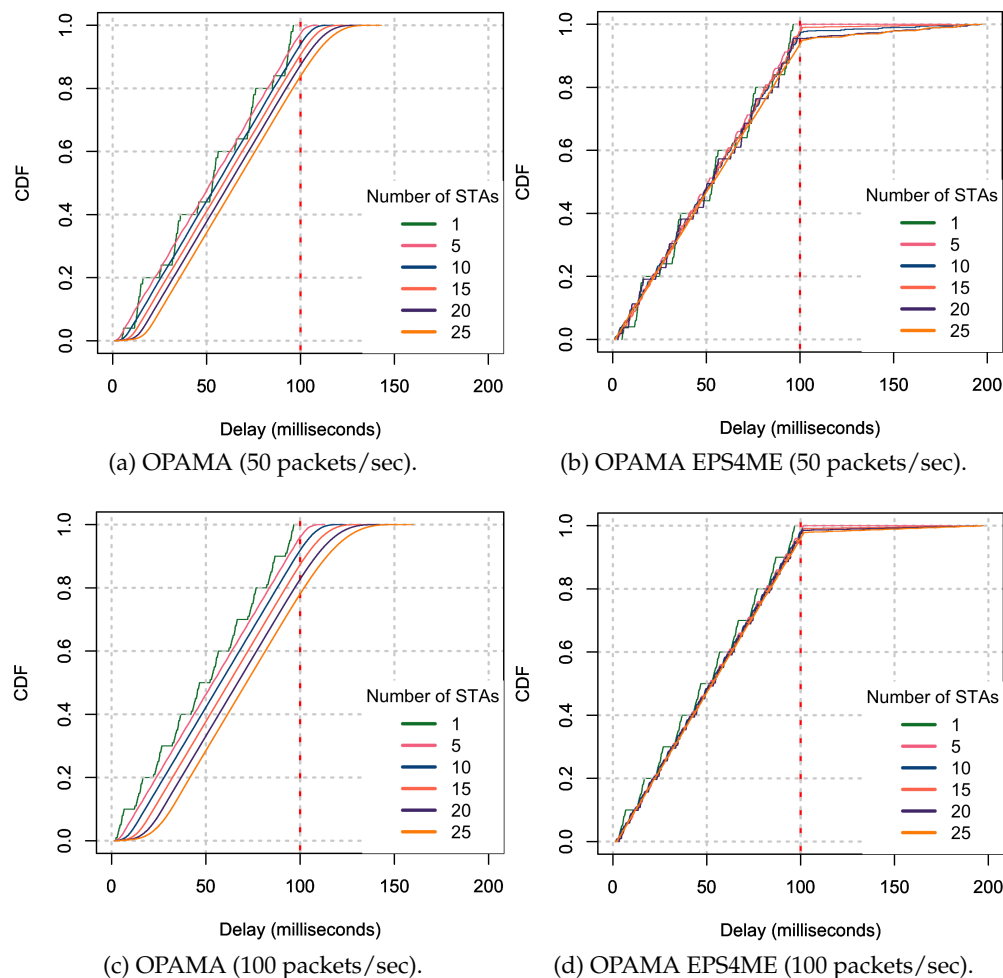

Figure 5.21: OPAMA delay CDF with different CBR transmission rates and mechanisms

10 stations, the energy savings attained with OPAMA-EPS4ME are around 62%, while with 15 and 20 stations in the network the savings decrease to around 24% and 10%, respectively.

With 25 stations, OPAMA-EPS4ME uses slightly more energy than OPAMA. The reasons for this behavior are twofold. First, when employing EPS4ME with larger number of stations the polling interval between each station with buffered data is shorter. Second, the smaller polling interval between STAs, together with the higher bandwidth imposed by the video traffic, increases the collision probability and, subsequently, the total unnecessary time in awake state (i.e., extra energy is consumed).

5.4 Enhancing Power Saving Mechanisms for Multiple Station Environments

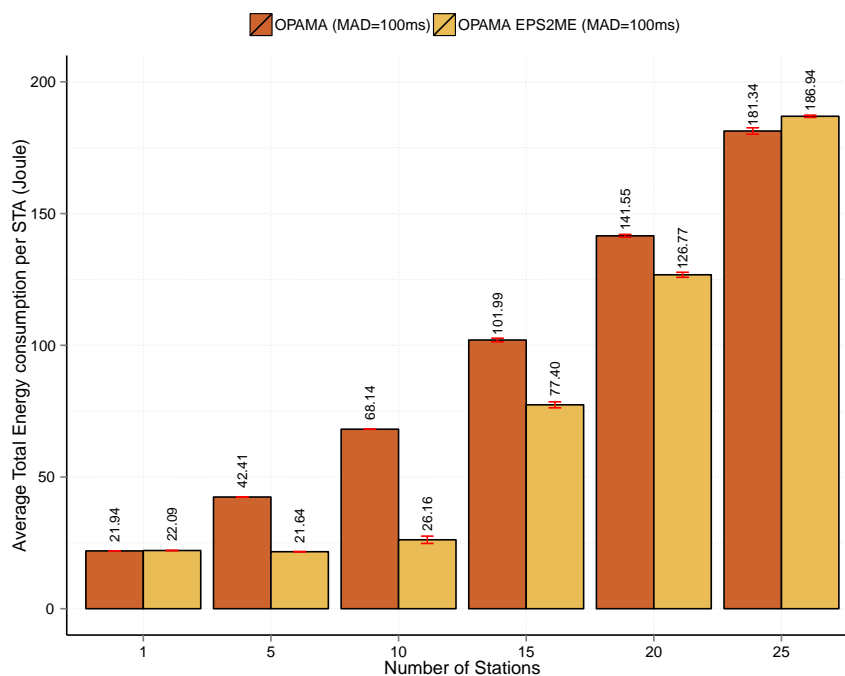

Figure 5.22: OPAMA average energy consumption per STA receiving video with the distinct mechanisms.

OPAMA-EPS4ME impact on the delay, compared with original OPAMA, is illustrated in Figure 5.23, which depicts the delivery data delay CDF.

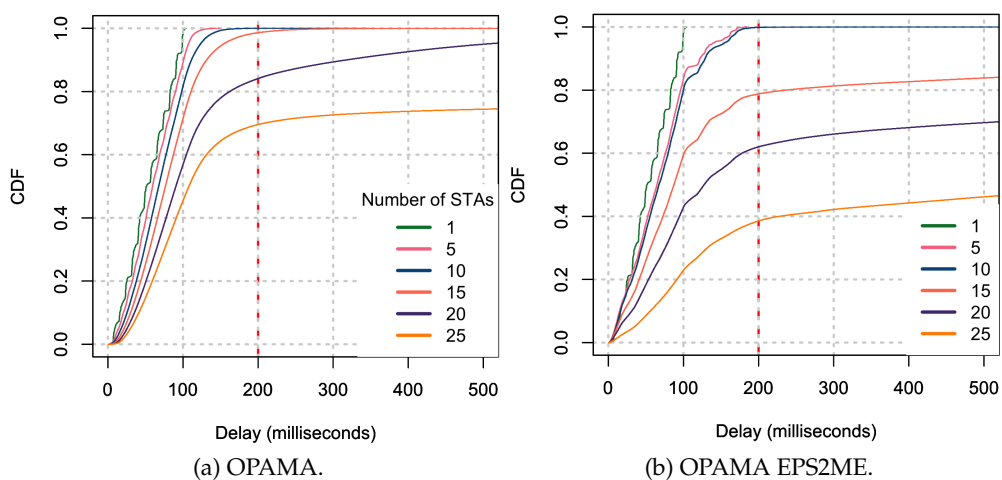

Figure 5.23: OPAMA delay CDF with different mechanisms receiving video.

5. Power Saving Mechanisms in Multiple Station Environments

When there are up to 10 stations in the network the delay pattern with OPAMA-EPS4ME is similar to OPAMA. With 15 or more stations, OPAMA-EPS4ME delays are higher than with OPAMA. For instance, with 20 stations, the percentage of delivered packets with a delay lower or equal than 200 ms is around 82% and 60% for OPAMA-ESP4ME and OPAMA, respectively. Such QoS performance limitation has impact on the QoE perceived by the end-users, as depicted by the SSIM metric illustrated in Figure 5.24. The EPS4ME energy saving / QoE trade-off is very good with up to 10

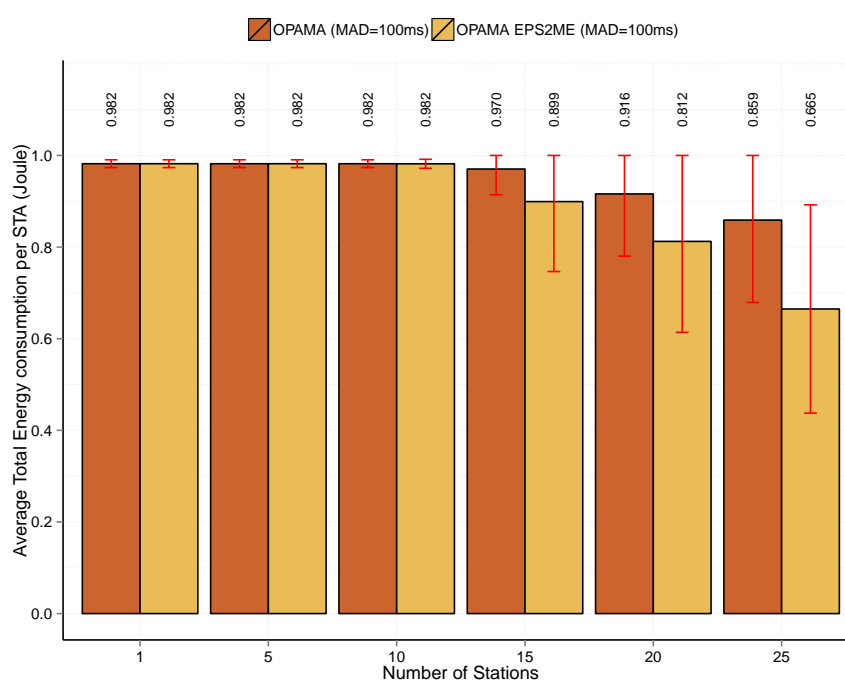

Figure 5.24: OPAMA average SSIM per STA receiving video with the distinct mechanisms.

stations in the network, as the same quality can be achieved with energy savings up to 60% (10 STAs scenario). With 15 stations in the network, the average SSIM using OPAMA is 0.970, while using OPAMA-EPS4ME the SSIM decreases to 0.859. Furthermore, when employing the EPS4ME mechanism, the SSIM uncertainty is higher when compared with original OPAMA, as illustrated by the larger confidence interval on the top of each bar.

Although OPAMA-EPS4ME shows limitations in the presence of the employed video sequence and higher number of stations, it should be highlighted that it revealed capabilities to achieve considerable energy savings (e.g., > 50%) in various scenarios.

The EPS4ME proposal does not require any modification in the IEEE 802.11 standard protocol messages or any extra data to be carried in each frame. Only a certain delay, in the individual polling action of STA, is added. The stations with lower identification in the AP will always be served first, as discussed. Such drawback can be further addressed by sending extra scheduling data in the beacon frames. Nevertheless, the main goal concerning this proposal was attained, as it was designed to address the core issue identified when employing the power saving mechanisms within multiple stations scenarios.

5.5 Summary

This chapter discussed the energy-efficiency / quality trade-off of various IEEE 802.11 energy saving mechanisms when used within a multiple stations environment. The assessment, performed in OMNeT++, comprises the usage of distinct applications, namely CBR synthetic traffic and VBR video streaming.

The attained results show that OPAMA has better capabilities to support multiple stations environments, when compared with the other mechanisms under study, namely No-PSM, Legacy-PSM and U-APSD. With several stations in the network, OPAMA reveals considerable energy savings, while keeping the end-users quality up to the desired level. The distinct STA-MAD configuration tested in OPAMA showed the importance of end-users feedback when using power saving mechanisms, as non negligible energy savings can be obtained for users supporting higher delays.

Even though OPAMA performed better than the other mechanisms, its energy-efficiency showed to be directly related with the number of stations in the network. Trying to overcome this issue, an Enhanced Power Saving Mechanism for Multiple station Environments (EPS4ME) has been proposed. OPAMA-EPS4ME overcomes the main limitation observed in OPAMA, leading to superior energy savings in several multiple stations scenarios. Notwithstanding, OPAMA-EPS4ME also showed to be influenced by the number of stations in the network and by the application traffic pattern.

Concerning the energy / quality trade-off, when compared with the remaining mechanisms tested, both OPAMA and OPAMA-EPS4ME can guarantee acceptable QoE to the end-users, with significant energy savings. Nevertheless, one should take into account that, besides the physical network conditions, the application pattern and number of stations in the network also plays an important role regarding the effectiveness of these mechanisms.

5. Power Saving Mechanisms in Multiple Station Environments

— *If the facts don't fit the theory,
change the facts.*

Albert Einstein

6

OPAMA in Android devices

THIS chapter investigates the energy/delay trade-off of using end-user driven power saving approaches in a real testbed using an Android mobile device. Section 6.1 introduces the chapter subject. Section 6.2 gives an overview of Android operating system, followed by the Android testbed presentation in Section 6.3. The Android testbed empirical validation is discussed in Section 6.4. The Android framework for Extending Power Saving control to End-users (EXPoSE) is presented in Section 6.5. In Section 6.6 the OPAMA implementation in Android is discussed and compared with the standard IEEE 802.11 power saving mechanisms. Finally, Section 6.7 summarizes the chapter findings.

6.1 Introduction

Android [Android Open Source Project, 2015] platform is responsible for a large part of the mobile device market growth, playing an important role in the energy efficiency of various battery-supported devices. As IEEE 802.11 standard becomes *de-facto* standard for wireless access interface among portable devices, its energy management mechanisms and efficiency within Android platform should be carefully investigated.

6. OPAMA in Android devices

This chapter assesses, using a real testbed, the most popular IEEE 802.11 power saving techniques implemented on the Android platform and compares them with the OPAMA proposal presented in Chapter 4. The algorithms under study include No-PSM, Legacy-PSM and the Android specific Adaptive-PSM scheme. Unfortunately, there is no U-APSD implementation available in Android and this scheme can not be tested. Additionally, an Android framework for Extending Power Saving control to End-users (EXPoSE) is proposed, aiming at improving the devices' energy efficiency by considering end-users demands.

Some of the implementation and testing tasks were performed together with Master student Bruno Correia.

6.2 Overview and Motivation

Android is an open source operating system (OS), based on Linux, which is being widely used in mobile devices. As In this context, the battery management is a critical issue to be addressed. The proliferation of IEEE 802.11 ready devices running Android reveals the need to perform a proper management of the Android IEEE 802.11 interface.

Apart from the standard IEEE 802.11 power saving techniques already described in the thesis, namely No-PSM and Legacy-PSM, the Android operating system provides specific power saving schemes (e.g., Adaptive-PSM) that are implementation dependent. The Android Kowalski Kernel [Cerrato, 2015], used in all Android devices tested in this chapter, implements an Adaptive-PSM mechanism named FastPSP. This Adaptive-PSM approach changes the IEEE 802.11 network interface between No-PSM and Legacy-PSM modes, depending on the network traffic. When considerable traffic is being received from the AP, the Adaptive-PSM keeps the network interface in No-PSM mode, backing into Legacy-PSM after the complete the reception of all the packets.

Recent studies [Cui et al., 2013] have shown that the wireless interfaces of mobile devices represent a non-negligible part of the total energy consumed. Therefore, aiming at saving energy, it is important to investigate the possibilities to enable a proper management of the Android IEEE 802.11 interface. Figure 6.1 illustrates the Android IEEE 802.11 architecture.

To manage the configurations of the IEEE 802.11 interface (WiFi) applications must interact with the *“WiFi Manager”*, which handles the communication with the *“WiFi Service”*. *“WiFi Service”* controls WiFi related communication between end-user and

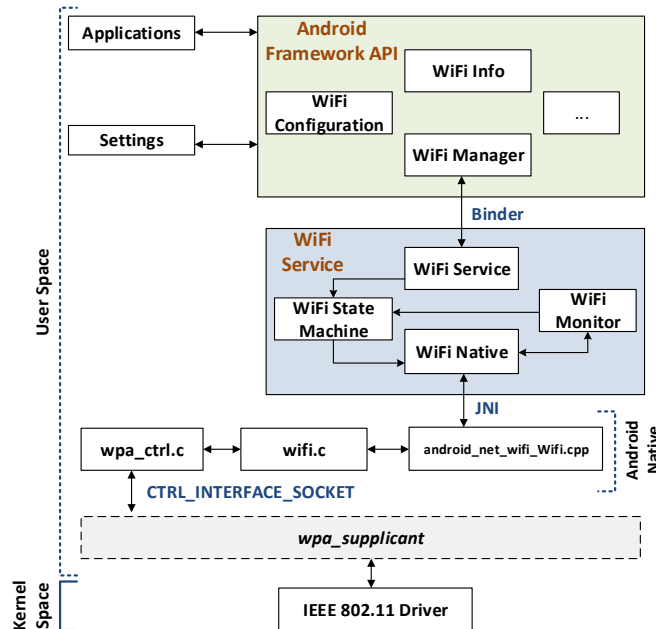

Figure 6.1: Architecture of IEEE 802.11 in Android. (Based on [Amuhong, 2015])

kernel spaces, being responsible for managing (“*WiFi State Machine*”) and translating (“*WiFi Native*”) all the requests. “*WiFi Native*” interfaces with the WiFi library, available as Android native code, through Java Native Interface (JNI). Finally, all the lower level calls to the IEEE 802.11 driver are performed through the “*wpa_supplicant*”.

Although the IEEE 802.11 architecture of Android is clear and well defined, it does not expose any IEEE 802.11 sleep related feature in the “*Application Framework API*” nor in the “*WiFi Service*”. Therefore, the defined architecture does not allow the management of the IEEE 802.11 sleep functions at higher-layers (e.g., application). This chapter addresses this issue by proposing enhancements to the current IEEE 802.11 architecture in Android, allowing power saving to be controlled by end-users.

6.3 Android Testbed

This subsection presents the IEEE 802.11 testbed and the energy measurement methodology to assess energy consumption of mobile phones.

Figure 6.2 illustrates the IEEE 802.11 testbed, which includes the Android mobile phone device as “*Mobile Node*”. The “*Mobile Node*” used in this setup was a LG P990 mobile phone (Figure 6.3b), running Android 4.2.2 and the “*Access Point*” was a Cisco Linksys E4200.

6. OPAMA in Android devices

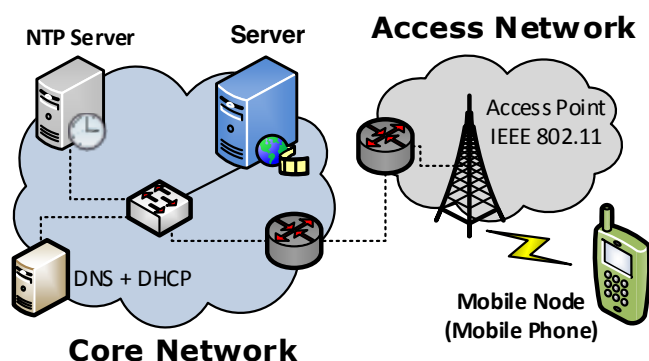

Figure 6.2: IEEE 802.11 testbed architecture encompassing Android mobile device.

The machines in the *Core Network* (“Server”, “NTP Server”, and “DNS+DHCP” entities) were virtualized and run in a HP ProLiant DL320 G5p server. Besides the “Mobile Node”, all the other machines were running Debian 7.0. All the traffic generated in the following tests has “Server” as source and “Mobile Node” as destination. Traffic generation was performed using the D-ITG tool version 2.8.1 [Botta et al., 2012].

The energy assessment testbed for mobile devices is detailed in Figure 6.3.

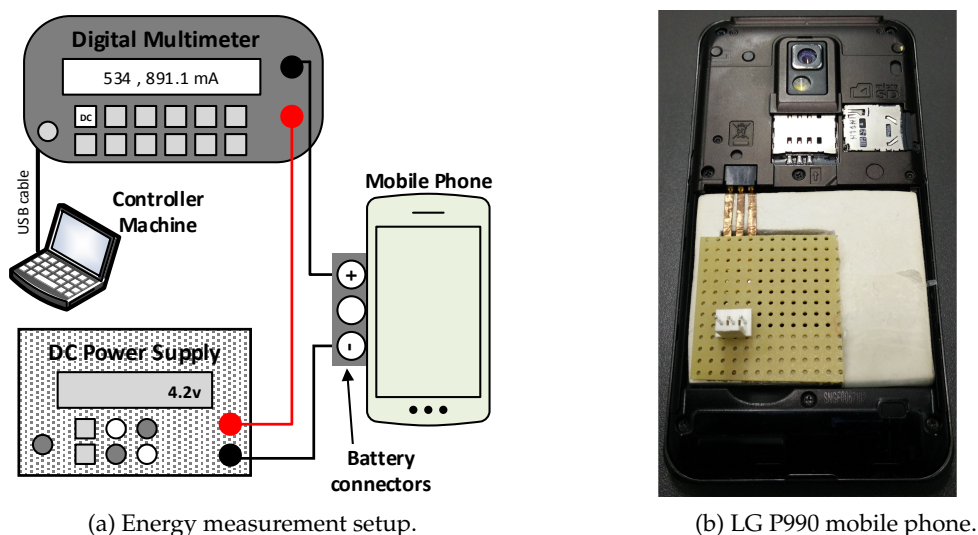

Figure 6.3: Energy measurement testbed for mobile devices.

The mobile phone energy consumption assessment was addressed by extending the EViTEQ framework proposed in Chapter 3 to support mobile devices.

Rice et al. [Rice and Hay, 2010] were one of the first to explore the energy con-

sumption in mobile phones. They proposed a methodology where a plastic battery holder replaces the battery, allowing the battery drop to be measured by using a high-precision measurement resistor in series between the holder cables and the battery. Although the accuracy behind this approach might be enough to measure mobile phone energy consumption, it still depends on the battery discharging pattern. Therefore, in the methodology used in this chapter, an external “DC Power Supply” was employed.

Nevertheless, as the mobile phone is expecting to receive battery status information via the smart battery system, the external power supply can not be directly used. This limitation was addressed by replacing the battery by a polymer clay model (Figure 6.3b), and by employing a specific voltage to allow the RT9524 unit of LG P990 (unit that controls the phone charging process) to be changed to “Factory Mode”. In this mode the phone can work without any battery status information, allowing the system to be supplied using an external power supply and without connecting a battery.

The energy consumption of the IEEE 802.11 interface described in the next sections is given by the difference between the mobile phone total energy consumption and the baseline energy consumption with the device operating in airplane mode (all radios off) with the display brightness at 100%. Each performed test has a duration of 60 seconds, and all the results presented include 20 distinct runs with a confidence interval of 95%.

6.4 Android Testbed Experimental Validation

This section describes the experimental validation performed in the testbed. The experimental validation main goal is to study the standard IEEE 802.11 power saving schemes, implemented in Android, in the presence of continuous media applications. The study includes the analysis of both energy efficiency and network-level performance metrics (e.g. delay) and the assessment of different application design options (e.g. packet size).

The following sections discuss the obtained results regarding the No-PSM, Legacy-PSM and Adaptive-PSM performance in Android devices, when receiving data from a continuous media application.

6.4.1 Impact of Packet Size

This section discusses the impact of the packet size in energy consumption of the three power saving approaches in study, namely No-PSM, Legacy-PSM and Adaptive-PSM. The data was sent with a fixed transmission rate of 100 packets per second. The packet size ranges from 200 to 1400 bytes. Figure 6.4 depicts the total energy consumed by the IEEE 802.11 interface (in Joule) during 60 s by each power saving algorithm, according to the employed packet size in bytes (x-axis).

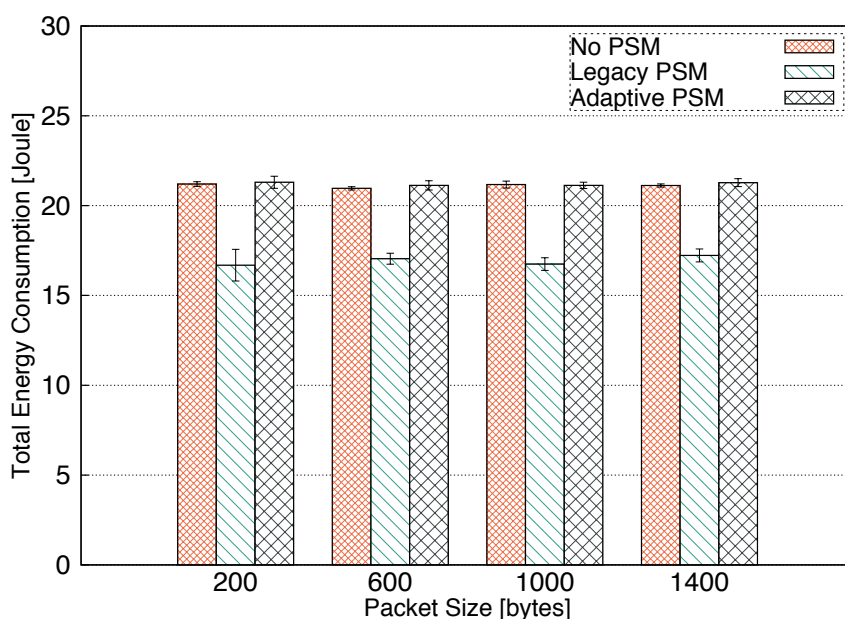

Figure 6.4: Total energy consumed by the IEEE 802.11 interface with different packet sizes.

The obtained results depict the Adaptive-PSM limitations in the presence of continuous media applications. Since in these applications there will be always data being transmitted from the core network to the mobile phone, the Adaptive-PSM algorithm does not have enough opportunities to sleep. Furthermore, due to the energy costs of multiple transitions between awake and sleep modes, this dynamic approach might consume more energy than No-PSM. When employing Legacy-PSM the energy savings are between 18% and 21% compared to No-PSM and Adaptive-PSM schemes, respectively.

The packet size has a negligible impact on the total energy consumed. Such results highlight the energy benefits of using larger packets, since the energy cost per transmitted bit will be much lower.

6.4 Android Testbed Experimental Validation

Besides the energy consumption behavior, the impact of power saving algorithms on application performance should also be considered. Figure 6.5 shows a *boxplot* representing the one way delay, in milliseconds, for all the packets transmitted using the different algorithms. Figure 6.5a depicts the delay for all the algorithms, while Figure 6.5b zooms the same data only for No-PSM and Adaptive-PSM schemes.

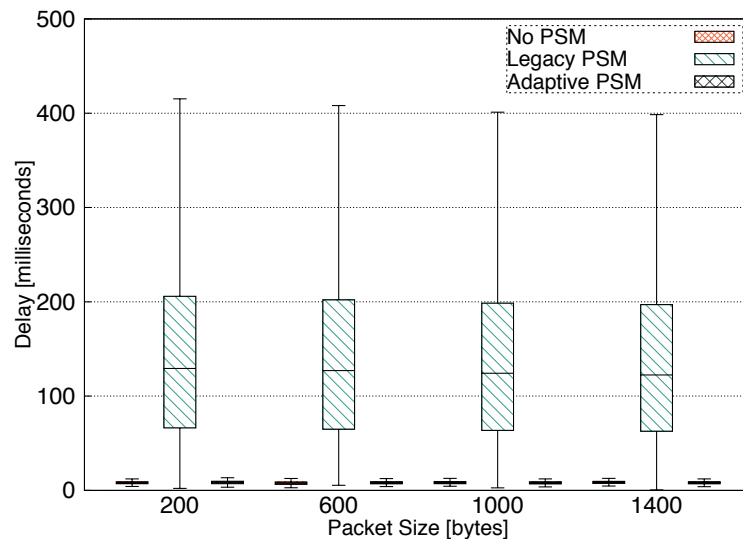

(a) One way delay for all algorithms

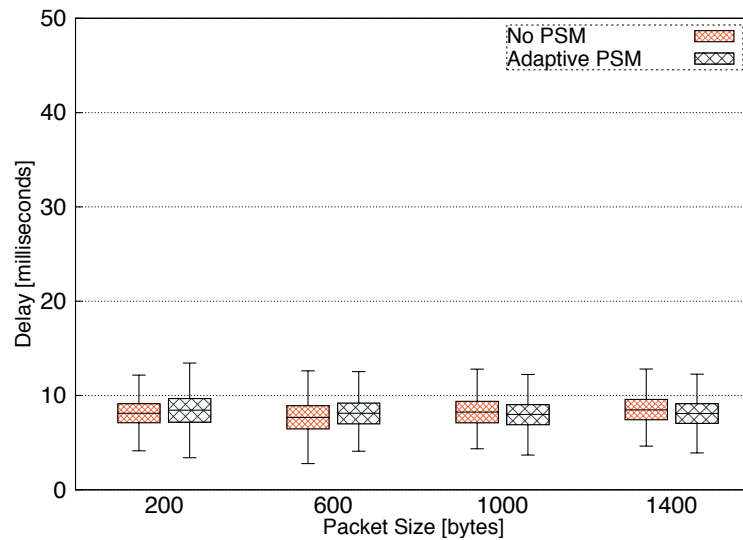

(b) One way delay for No-PSM and Adaptive-PSM

Figure 6.5: One way delay for different packet sizes.

Legacy-PSM introduces considerably more delay, when compared to No-PSM and

6. OPAMA in Android devices

Adaptive-PSM. The mean delay (second quartile) obtained for the Legacy-PSM is around 125 ms, while for No-PSM and Adaptive-PSM the mean delay is between 7 and 9 ms. Additionally, the No-PSM and Adaptive-PSM maximum delay never exceed 14 ms, while the Legacy-PSM has delays up to 400 ms. Again, the packet size does not reveal any impact on the results.

These results show that the energy savings (between 18% and 21%) obtained with the Legacy-PSM do not establish a good energy / performance trade-off, since there is a high impact on the application delay. Due to the polling phase, Legacy-PSM also generates packet losses, but always lower than 0.2%. Furthermore, the impact of packet size on the energy consumption is almost absent. Concerning the application design, the depicted data showed that using larger packets is highly preferable to improve overall energy consumption.

6.4.2 Impact of Transmission Rate

This subsection investigates the impact of the transmission rate on total energy consumption of No-PSM, Legacy-PSM and Adaptive-PSM. In this evaluation the packet size was fixed to 1000 bytes, with the transmission rate varying between 50 and 250 packets per second. Figure 6.6 presents the total energy consumed by the IEEE 802.11 interface (in Joules) during 60 s with different transmission rates (x-axis).

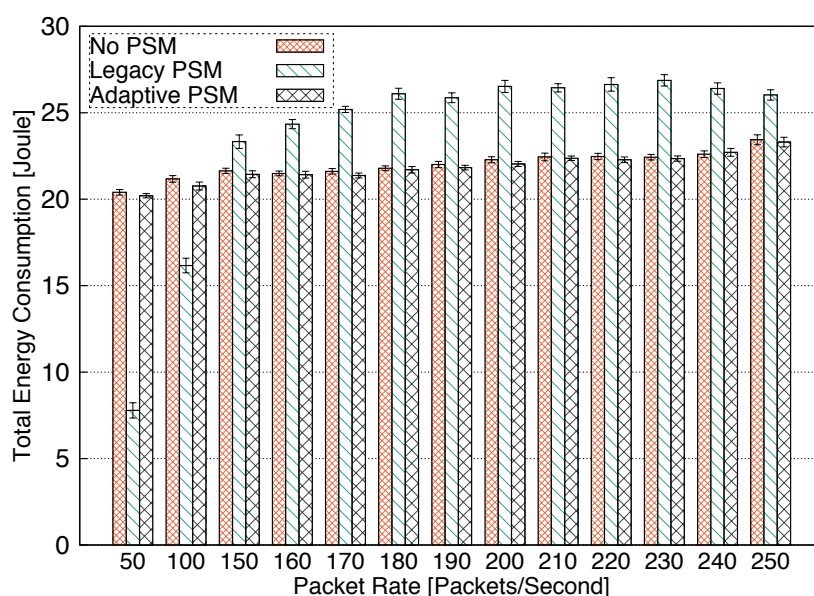

Figure 6.6: Total energy consumed by the IEEE 802.11 interface with distinct transmission rates.

The results show that in both No-PSM and Adaptive-PSM it is possible to establish a linear relationship between the energy consumption over time and the transmission rate. When using Legacy-PSM, the energy consumption also increases with transmission rates, but only for rates up to 180 packets per second. With transmission rates above 180 packets per second, Legacy-PSM energy consumption is almost constant. Furthermore, Legacy-PSM only outperforms No-PSM and Adaptive-PSM for the lowest studied transmission rates.

In order to properly investigate the Legacy-PSM behavior, the one way delay and packet loss metrics were analyzed. No packet loss was detected with the No-PSM and the Adaptive-PSM schemes, and the mean delay ranges between 7 and 9 ms. The maximum delay observed was always lower than 14 ms. The *boxplot* depicting the delay and the packet loss rate for the Legacy-PSM are illustrated, respectively, in Figures 6.7a and 6.7b.

The Quality of Service (QoS) attained using Legacy-PSM is strongly affected by the transmission rate, as depicted by the mean delay for rates greater or equal than 160 packets per second. Apart from the unacceptable delay, Legacy-PSM also affects application performance by introducing a non negligible packet loss for rates above or equal to 190 packets per second. Such behavior is related to the Legacy-PSM protocol design, where the device must send one *PS-Poll* to the access point to request each pending frame [Tsao and Huang, 2011]. The long delays resulting from the protocol polling mechanism also explain the depicted packet loss, since various packets are dropped in the access point queues due to time constraint violations.

In short, when analyzing the behavior of Legacy-PSM and Adaptive-PSM we conclude that they are not able to establish a proper energy / performance trade-off for continuous media applications. Legacy-PSM strongly affects the application performance, whereas the Adaptive-PSM can keep the application requirements, but without achieving significant energy savings.

The following section details the IEEE 802.11 implementation in Android and its main limitations concerning the available energy managements capabilities. Additionally, it presents an Android framework for Extending Power Saving control to End-users.

6. OPAMA in Android devices

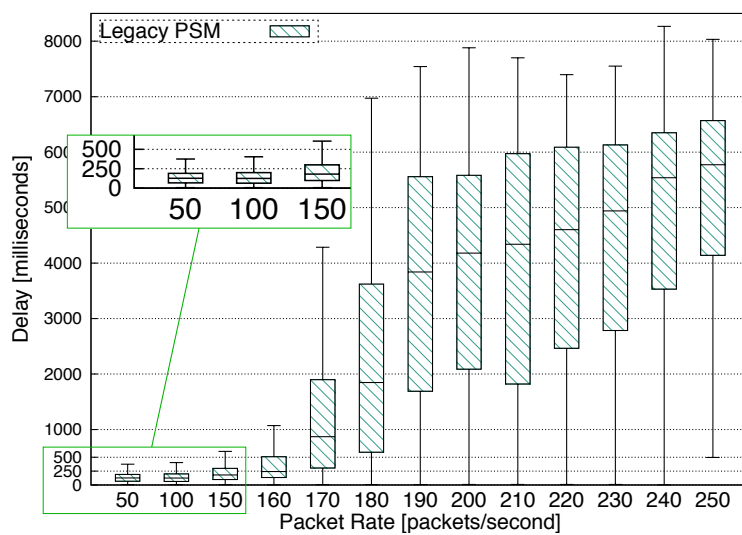

(a) One way delay

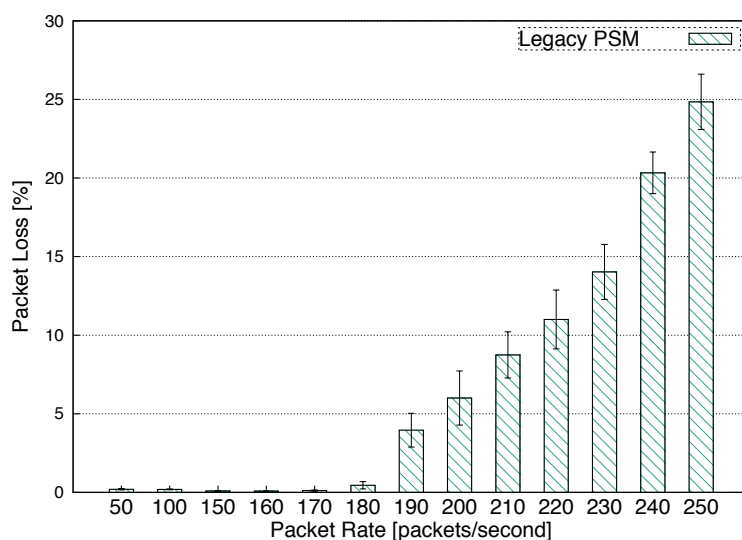

(b) Packet loss rate

Figure 6.7: One way delay and loss rate for Legacy-PSM with distinct transmission rates.

6.5 EXPoSE: An Android Framework for Extending Power Saving Control to End-users

This section presents EXPoSE framework in Subsection 6.5.1, followed by discussion of its validation assessment in Subsection 6.5.2.

6.5.1 EXPoSE Design

This subsection presents the Android framework for Extending Power Saving control to End-users (EXPoSE) design.

Figure 6.8 illustrates the architecture of the EXPoSE framework. The EXPoSE fra-

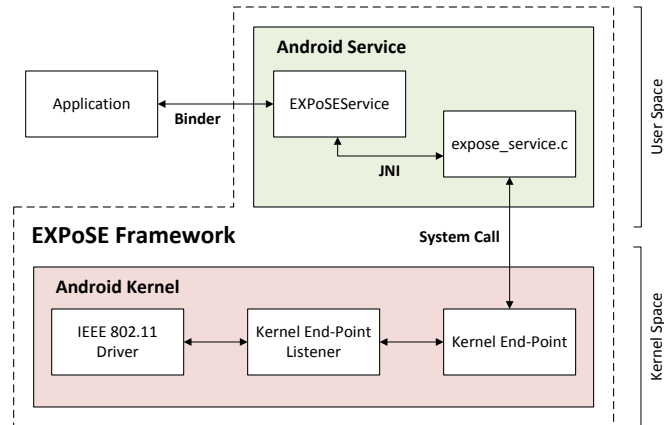

Figure 6.8: EXPoSE framework architecture.

mework was implemented as an Android service (EXPoSE Service), plus a lower level control module included in the Android kernel. This module allows the IEEE 802.11 power saving functions to be exposed to higher level layers, enabling better control of power states.

To enable generic communication with the IEEE 802.11 driver, the developed Android kernel module is composed of two distinct components: the “*Kernel End-Point*” and the “*Kernel End-Point Listener*”. The communication between the kernel end-point and the driver is performed through the proposed kernel end-point listener. Such abstraction plays an important role concerning energy efficiency, since, although the listener is always active, it is waiting in a semaphore and does not perform any additional processing (with extra energy costs).

Concerning the communication with the applications, the EXPoSE service can be configured in two distinct ways:

- ▶ **Pattern-based:** allows the application to configure the awake/sleep pattern over time. For instance, an application can specify that it must be awake for a certain period, α milliseconds, and it must be in sleep mode for a period of β milliseconds;
- ▶ **Acceptable delay definition:** enables the application to define a delay con-

6. OPAMA in Android devices

straint, whereas a delay of γ milliseconds is tolerable. The control of the awake/sleep pattern over time will be performed by the EXPoSE service, taking into account the delay bound restriction.

To use the pattern-based approach, an application should inform, at least, three distinct values. The first value is a flag to indicate if the specified pattern should be repeated over time. Such flag should be followed by two parameters, α and β , respectively, the awake and sleep periods in milliseconds. When using the MAD approach the application should only indicate a single value, γ , representing the maximum allowed delay in milliseconds.

As default Android Adaptive-PSM, the EXPoSE service also performs regular switching between sleep and awake modes. However, unlike Adaptive-PSM, the power modes switches do not depend on the traffic load, but rather on application or end-users requirements. To change the IEEE 802.11 network interface to sleep mode for a certain period, EXPoSE changes the power mode on the IEEE 802.11 driver, forcing a NULL data frame with the Power Management flag enabled to be sent to the AP. Such action informs the AP that incoming data for that station should be queued, as in Legacy-PSM. Once the defined sleep period expires, the EXPoSE framework forces the interface to go back into awake mode and sends a NULL data frame to the AP with Power Management flag set to 0, allowing the queued data to be transmitted without any polling message.

The “EXPoSE service” interacts with the IEEE 802.11 driver through the “Kernel End-Point” by sending the time, in milliseconds, that the IEEE 802.11 network interface must be in sleep mode. Once the configured time expires, the “Kernel End-Point Listener” puts the interface back into awake mode. This scheme minimizes the interactions between user and kernel spaces, leading to a better system level performance.

6.5.2 Experimental Evaluation

This subsection describes the validation assessment performed in the testbed, encompassing tests with both EXPoSE approaches.

6.5.2.1 EXPoSE Pattern-based Sleep Approach:

This section explores the employment of EXPoSE using the pattern-based sleep approach configured by the application, as described in Section 6.5.1. All the results presented next were performed using a fixed packet size of 1000 bytes with a constant

6.5 EXPoSE: An Android Framework for Extending Power Saving Control to End-users

transmission rate of 200 packets per second. This configuration was selected, since it represents a scenario where the Legacy-PSM performance is already worse than both No-PSM and Adaptive-PSM (see Figure 6.6).

As the goal of this assessment is to study the EXPoSE impact on the energy consumption and network performance, 9 distinct sleep patterns were selected as illustrated in Table 6.1. Apart from the parameters required to configure the EXPoSE pattern-based solution, the table also depicts a constant, κ , associated with each test. This constant allows to establish a relationship between the configured periods, that means $AwakePeriod = \kappa \times SleepPeriod$.

Table 6.1: EXPoSE pattern-based configurations

Test ID	T1	T2	T3	T4	T5	T6	T7	T8	T9
Loop Flag	1	1	1	1	1	1	1	1	1
SleepPeriod (ms)	30	30	30	60	60	60	120	120	120
AwakePeriod (ms)	90	30	10	120	60	20	360	120	40
κ	3	1	1/3	3	1	1/3	3	1	1/3

Figure 6.9a shows the EXPoSE pattern-based solution energy savings compared to Adaptive-PSM for the different configurations.

As expected, the results show a direct relationship between the energy savings and the total time in sleep mode. Even for the scenarios with $\kappa=3$, where the time in sleep mode is 25% of the total time, the energy savings are up to 17.93% for the scenario with a sleep period equal to 120 ms. When reducing the awake period, an improvement in energy savings can be observed. With $\kappa=1$, where the awake and sleep periods are equal, the savings are up to 26.90%. If the awake period is reduced to 1/3 of the sleep period (i.e., $\kappa=1/3$) energy savings are 23.45%, 39.24% and 44.00% for configured sleep periods of 30, 60 and 120 ms, respectively.

The delay results, depicted in Figure 6.9b, show that EXPoSE impact on the delay is not negligible, such as for Adaptive-PSM. For a similar scenario (with a rate of 200 packets per second and using packet size of 1000 bytes) the Legacy-PSM mean delay is around 4s, with a maximum delay higher than 7s. Moreover, packet loss with EXPoSE pattern-based approach was always lower than 0.02%, against 6.00% with Legacy-PSM.

In the studied scenarios, the EXPoSE pattern-based approach shows mean delays below 100 ms, enabling the possibility to be employed with continuous media application, as for instance, video streaming.

6. OPAMA in Android devices

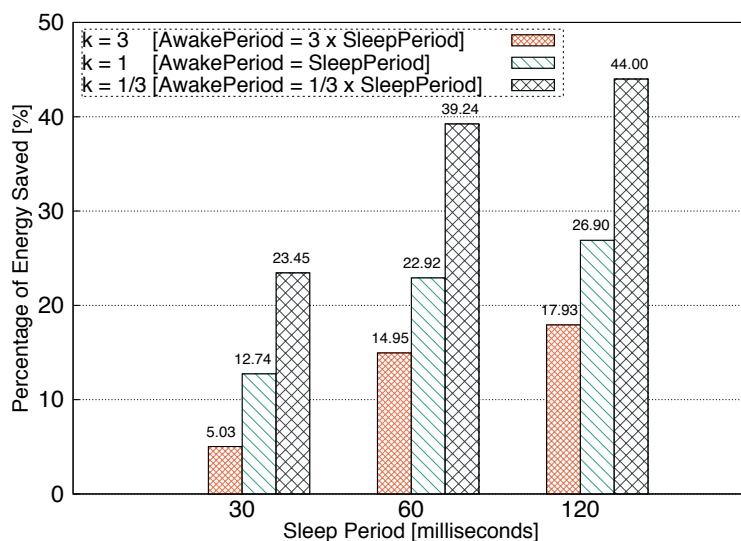

(a) Energy savings of EXPoSE compared to Adaptive-PSM

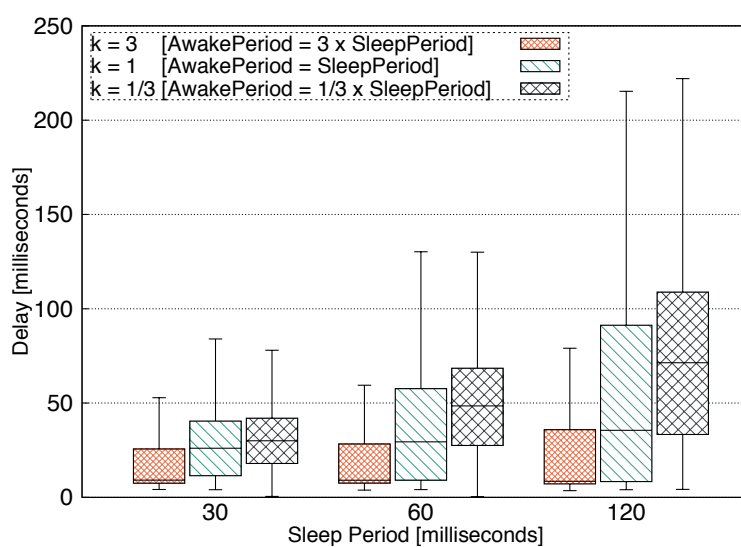

(b) One way delay

Figure 6.9: Energy savings and one way delay for EXPoSE pattern-based approach.

6.5.2.2 EXPoSE Acceptable Delay Definition Approach:

This subsection studies the EXPoSE acceptable delay definition approach. In this evaluation, two applications were selected: one which tolerates delays equal to 100 ms, and another tolerating delays up to 200 ms. Both applications were emulated using a transmission rate of 200 packets per second, with packets of 1000 bytes length.

The main objective of EXPoSE's acceptable delay definition approach is to keep

the application QoS requirements within specified bounds. Therefore, this subsection investigates the minimum awake period required not to exceed the defined tolerable delay. As defined in the EXPoSE acceptable delay mechanism, by default, the sleep period will be equal to the configured acceptable delay.

Figure 6.10a shows the energy savings percentage in relation to the Adaptive-PSM algorithm on the y-axis, while the x-axis depicts the tested awake periods, ranging from 50 ms to 500 ms. The one way delay for the same assessment is illustrated in Figure 6.10b.

The results show that to keep the application delay within the defined bounds, the awake period should be defined as 300 ms and 450 ms for acceptable delays of 100 ms and 200 ms, respectively. Energy savings for the lowest acceptable delay are 13.77% and 23.53% when the application supports delays up to 200 ms, respectively. Nonetheless, if the application allows that only 75% of the packets (*boxplot* third quartile) arrive within the configured limits, it is enough to be awake during 50 ms and the energy savings for 100 ms and 200 ms maximum allowed delay are 38.50% and 54.44%, respectively, compared to Adaptive-PSM.

6.6 OPAMA in Android

This section presents the OPAMA implementation in Android devices. First, a detailed overview concerning the implementation is given, followed by the experimental evaluation presentation and results discussion.

6.6.1 Implementation of OPAMA in an Android Testbed

This section describes the OPAMA implementation in a real testbed. First, the OPAMA core algorithm implementation in the access point is presented, followed by the discussion regarding the required modifications in the Android system aiming at supporting OPAMA.

6.6.1.1 Access Point Implementation

The OPAMA mechanism implementation was performed based on the original OPAMA defined in Algorithm 1 (Section 4.2.2). The previously discussed, OPAMA algorithm is to be deployed at the AP. Since OPAMA requires modifications at the MAC layer, it must be implemented in hardware that allows a proper manipulation

6. OPAMA in Android devices

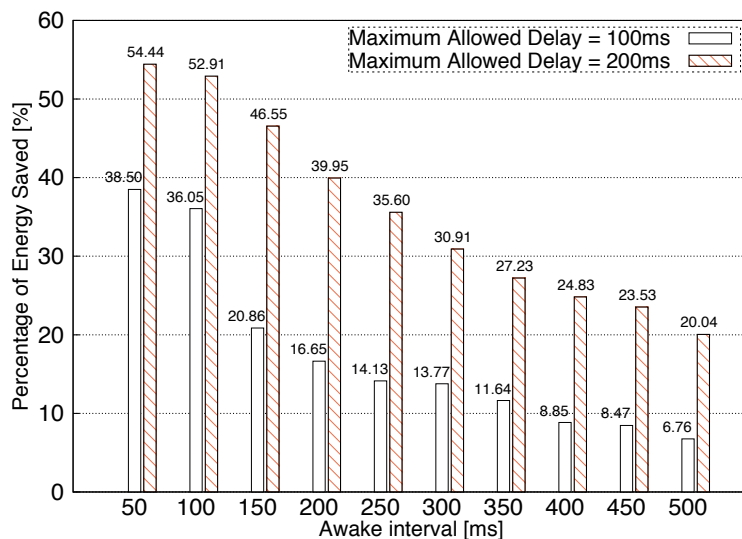

(a) Energy savings compared with Adaptive-PSM

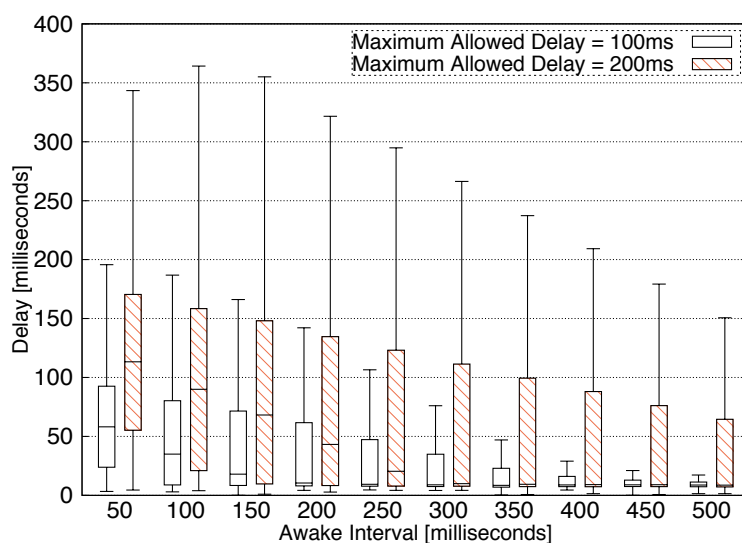

(b) One way delay

Figure 6.10: Energy savings and delay for EXPoSE maximum allowed delay scenarios.

at this level. Therefore, it is not possible to employ the Cisco Linksys E4200 commercial AP used in the previous section, as it is deployed with a proprietary and closed firmware.

To overcome this limitation, OPAMA was implemented in a Linux AP, encompassing the *hostapd* tool [Hostapd, 2015] as software access point. The *hostapd* is a user-space Linux daemon, which implements access point and authentication servers.

As *hostapd* can communicate directly with the driver using the *mac80211* kernel module, there is no need to perform any change. The Linux AP deployment was done in an Asus EEE 1001PX-H netbook (CPU: Intel Atom N450 1.66 GHz; RAM: 2Gb), running Debian 7.0 kernel version “3.2.0-4-686-pae”. The maximum queue length in the Cisco AP is 1024 frames, while this software-based AP only supports a maximum of 64 frames in the queue (default value in the kernel). Moreover, in the Cisco equipment, the *Beacon* frame interval with a presence of TIM information, known as DTIM, is equal to 3 and it cannot be modified. As OPAMA is designed to control the station behavior with the TIM information within each *Beacon*, the DTIM was defined as 1.

The OPAMA algorithm was implemented in the *mac80211* kernel module, allowing the required lower MAC layer level operation to be performed. Apart from enabling an easier management of the IEEE 802.11 frames, the *mac80211* framework ensures the implementation compatibility with various lower level drivers. Moreover, it is open-source and part of the Linux kernel tree.

The employment of aggregation techniques within OPAMA showed clear benefits, as depicted in the simulation study performed in Chapter 4. The *mac80211* kernel module supports the A-MSDU aggregation scheme used in OPAMA algorithm. However, although the A-MSDU support at the reception is mandatory in the IEEE 802.11n standard, the used LG P990 mobile phone, running Android 4.2.2, does not support it.

The OPAMA implementation in the *mac80211* kernel module was performed by extending the function responsible to broadcast the *Beacon* frames. This approach allows the TIM for each station to be defined according to the decision taken by the OPAMA algorithm.

6.6.1.2 Android Mobile Device Implementation

The IEEE 802.11 chipset used by the LG P990 mobile phone is the Broadcom “BCM4329” [Broadcom, 2015], which is widely used in mobile phones. In the Android 4.2.2, the “BCM4329” driver is implemented as FullMAC. When using FullMAC drivers, the MAC Sublayer Management Entity (MLME) functions are controlled directly by the hardware and not by a software abstraction layer. The MLME is the entity that implements the PHY / MAC state machine, being responsible for performing different IEEE 802.11 lower layer tasks, namely authentication, association, beacon reception, and probing, among others.

The FullMAC approach’s main disadvantage relates to the lack of accessing certain MAC layer functions and/or frames in the software layer. Such restrictions have

6. OPAMA in Android devices

a two-fold impact on the OPAMA implementation in Android. First, as the probing management is performed by the MLME PHY / MAC state machine directly in the hardware, it is not possible to extend the *PS-Poll* frame to include the OPAMA Maximum Allowed Delay (MAD) defined by the end-user. Second, the information comprised in the *Beacon* frames cannot be used in the software layer, meaning that *MORE-DATA* bit and TIM field information is only available in the MLME PHY / MAC state machine.

To overcome the limitations created by the lack of extending the *PS-Poll* frame, the OPAMA MAD was statically defined, for each station, in a configuration file at the AP. Although this solution does not allow the station to dynamically change the MAD through time, it nonetheless enables a full validation of this OPAMA feature.

As already discussed, OPAMA improves the Legacy-PSM polling mechanism by sending a single *PS-Poll* after each *Beacon*, containing pending information in the TIM field. This enhancement cannot be performed in the existing FullMAC approach, since the polling control is directly executed by the PHY / MAC state machine at the hardware level. This restriction was addressed by introducing an extra signaling message that allows the AP to explicitly inform the STA about the expected sleep status. Such extra information entitled the STA to change between No-PSM and Legacy-PSM modes, avoiding the unnecessary polling.

This explicit information exchange to control the Android mobile devices IEEE 802.11's network interface behavior was previously addressed by Han et al. [Han et al., 2012]. The employed signaling strategy, using a custom signaling message implemented on the top of Ethernet packet, reveals to have a negligible impact on the energy consumption results.

Therefore, aiming at reducing the overhead caused by the TCP/IP headers, the required signaling information to implement OPAMA in Android will also be encapsulated as an Ethernet packet, sent directly from the AP to the target STA. Figure 6.11 depicts the employed Ethernet packet fields.

The "*Destination MAC Address*" and "*Source MAC Address*" are the MAC addresses of the AP and the target STA, respectively. The "*EtherType*" represents the protocol type encapsulated in the Ethernet frame payload. To avoid protocol parsing conflicts, the OPAMA sleep control approach in Android uses a reserved "*EtherType*" value (*0xFFFF*). The usage of the reserved type guarantees that this control packet is not filtered by other applications. The packet identification is provided in the "*Sequence Number*" field. The "*Sleep Info Data*" contains the information needed to enable the proper power management according to the OPAMA specification. When defined as

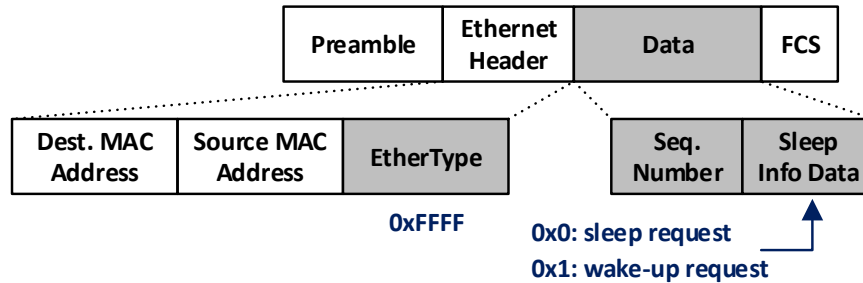

Figure 6.11: Ethernet packet to control the IEEE 802.11 modes.

“0x0” it informs the station that it should go into sleep mode (i.e., Legacy-PSM), while a value equal to “0x1” requests the station to wake-up (i.e., No-PSM).

This signaling mechanism allows the change between No-PSM and Legacy-PSM modes to be performed by the ExPoSE framework (Section 6.5). The OPAMA sleep control Ethernet packet for the target STA, running Android, will be filtered by an external kernel module. This module behaves as a “hook”, filtering all the Ethernet packets with “EtherType” value equal to 0xFFFF. Once a packet is filtered, the module is responsible for parsing the “Sleep Info Data” and to change the IEEE 802.11 power save mode through the ExPoSE framework. The ExPoSE framework is requested to modify the IEEE 801.11 interface to Legacy-PSM if the “Sleep Info Data” field is equal to 0x0, and to No-PSM if the sleep information data is set as 0x1.

As the OPAMA in Android has considerable differences when compared with original OPAMA, this implementation will be called Simplified-OPAMA. The main modifications performed in the Simplified-OPAMA implementation are as follows: 1) aggregation is not used; 2) usage of extra signaling, via Ethernet packets, to avoid unnecessary polling.

The next section presents an experimental evaluation regarding the Simplified-OPAMA performance when compared with other IEEE 802.11 power saving mechanisms available in Android.

6.6.2 Experimental Evaluation

This subsection discusses the performance of Simplified-OPAMA in Android when compared with other power saving mechanisms available in Android, namely No-PSM, Legacy-PSM and Adaptive-PSM. Following the approach used to validate the EXPoSE framework in Section 6.5.2.1, the tests were performed using a transmission rate of 200 packets per second and a packet size of 1000 bytes.

6. OPAMA in Android devices

Figure 6.12 depicts the percentage of energy saved by Simplified-OPAMA, using distinct STA-MAD configurations (x-axis), compared to the other algorithms under study.

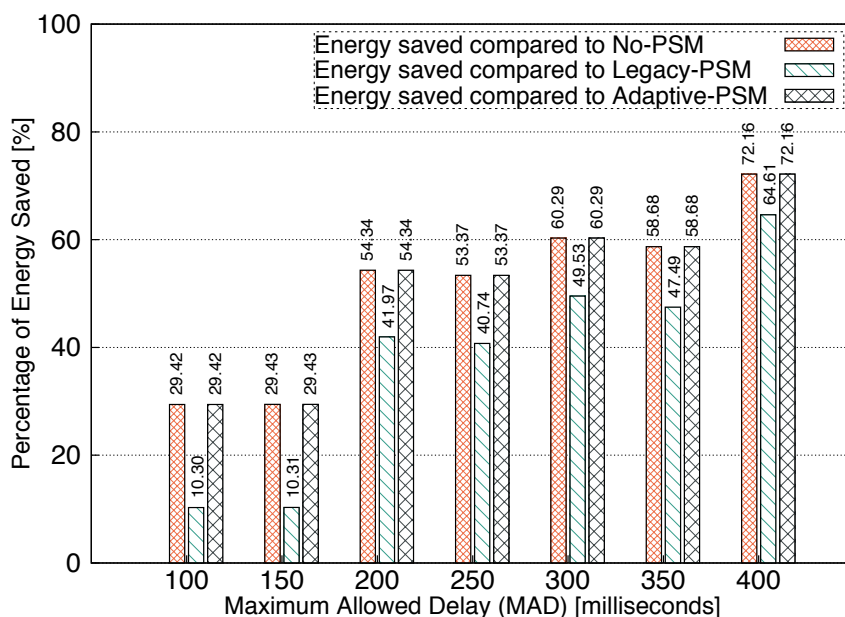

Figure 6.12: Energy saving of Simplified-OPAMA compared to the other algorithms under study.

The results depict that the Simplified-OPAMA capabilities achieve considerable energy savings when compared with No-PSM, Legacy-PSM and Adaptive-PSM algorithms. Adaptive-PSM energy consumption is similar to the No-PSM, meaning that it never had opportunities to sleep in the presence of continuous media applications.

When compared to Legacy-PSM, Simplified-OPAMA energy savings with STA-MAD=100 ms is 10.30% and 41.97% when STA-MAD=200 ms. If the STA-MAD=400 ms, the energy savings can go up to 64.61%. Similarly, compared to Adaptive-PSM, Simplified-OPAMA allows 29.42% and 54.34% of energy to be saved when STA-MAD is defined as 100 ms and 200 ms, respectively.

Besides analyzing the Simplified-OPAMA energy consumption, its network level performance, namely packet loss and delay, should also be analyzed. With No-PSM and Adaptive-PSM there are no packet losses for all the scenarios tested. When employing Simplified-OPAMA the packet loss never exceeds 0.01%, which has a negligible impact on the end-user quality perception [Y.1541, 2011]. Conversely, Legacy-PSM introduces an average packet loss rate of 5.80%, which reflects a similar behavior to

the one depicted in Figure 6.7b (transmission rate equals to 200 packets/sec).

Table 6.2 summarizes the one way delay values obtained with the standard mechanisms under study, including also Simplified-OPAMA with STA-MAD configured as 100ms.

Table 6.2: One way delay for all standard mechanisms under study and for Simplified-OPAMA with MAD=100ms

Name	Mean	Min.	First Quartile	Third Quartile	Max.
No-PSM	8.38	5.15	7.38	9.35	21.43
Legacy-PSM	48.91	5.77	28.61	67.41	448.95
Adaptive-PSM	8.43	5.47	7.42	9.40	22.25
Simplified-OPAMA (MAD=100ms)	50.04	4.94	27.49	71.99	126.62

Figure 6.13 shows a *boxplot* depicting the one way delay for Simplified-OPAMA with distinct maximum allowed delays.

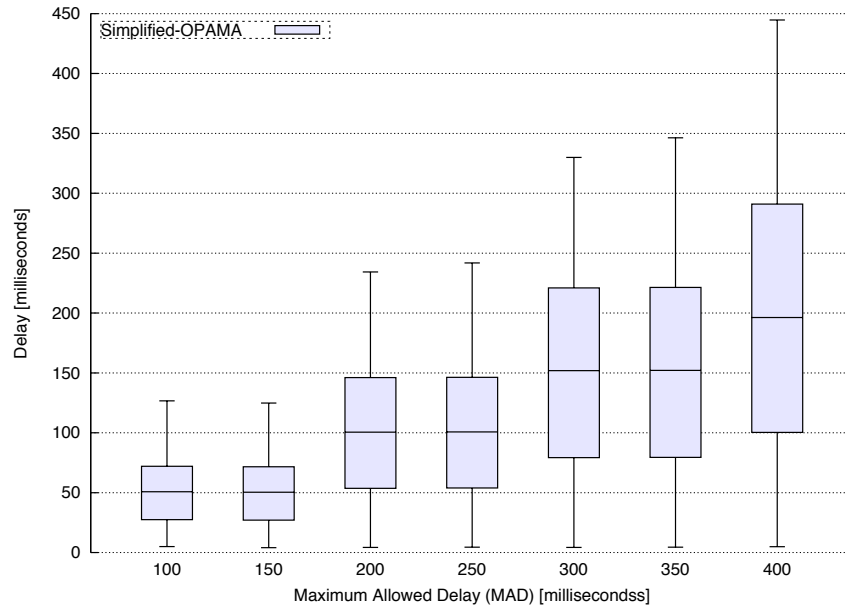

Figure 6.13: One way delay for Simplified-OPAMA with distinct maximum allowed delays.

The delay for No-PSM and Adaptive-PSM algorithms never exceeds 25 ms. Besides being an expected behavior for No-PSM, as frames are never queued in the AP, it also reinforces the Adaptive-PSM limitations in the presence of continuous media applications. The Legacy-PSM delay pattern is similar to Simplified-OPAMA with

6. OPAMA in Android devices

STA-MAD of 100 ms and 150 ms.

Unlike OPAMA, Simplified-OPAMA cannot guarantee the maximum allowed delay defined by the end-users for all the scenarios. Nonetheless, Simplified-OPAMA always guarantees the defined STA-MAD for 75% of the delivered packets (*boxplot* third quartile). This is mainly motivated by the lack of aggregation, leading to higher delays in the packet delivery.

One can observe that Simplified-OPAMA can guarantee the maximum delay configured for scenarios where the end-user has defined the STA-MAD as 150 ms, 250 ms and 350 ms. Moreover, the obtained delay pattern for 100 ms / 150 ms, 200 ms / 250 ms and 300 ms / 350 ms is similar. Such behavior is related with the OPAMA algorithm implementation. The algorithm is always executed before the AP sends each *Beacon*, meaning that it will run every 100 ms (default *Beacon Interval* value). Therefore, if there is constant traffic to be transmitted, using STA-MAD values that are not multiple of the *Beacon Interval* will produce the depicted behavior.

Nevertheless, Simplified-OPAMA is able to establish a proper energy / quality trade-off when compared with the other algorithms. Even with the identified limitations and required simplifications, Simplified-OPAMA shows the OPAMA proposal potential to be implemented in Android devices, leading to considerable energy savings, while taking the end-user preferences into account.

6.7 Summary

This chapter investigated the performance of IEEE 802.11 power saving techniques available in Android, namely No-PSM, Legacy-PSM and Adaptive-PSM. Furthermore, an Android framework for Extending Power Saving control to End-users (EXPoSE) was proposed, leading to the implementation of OPAMA in Android.

The achieved results showed that end-user driven power saving control in Android devices can achieve considerable energy savings. As an example, the employment of EXPoSE, namely the pattern-based and the acceptable delay definition approach, are more energy efficient than both Legacy-PSM and Adaptive-PSM schemes. Depending on the scenarios and applications requirements, the EXPoSE energy savings, compared to Adaptive-PSM, can go up to 23.53% without violating the application delay constraints.

Although without using aggregation and with extra signaling overhead, the OPAMA implementation in Android, Simplified-OPAMA, reveals the feasibility of implementing the OPAMA scheme in real Android devices. The obtained results

showed the Simplified-OPAMA's capability to support the end-user's delay requirements, while achieving considerable energy savings. For the scenarios supporting higher delays, Simplified-OPAMA's energy savings can go up to 64.61% and 72.16% when compared to Legacy-PSM and Adaptive-PSM, respectively. If the application delay is more restricted and only a maximum allowed delay of 100 ms is supported, the energy savings are 10.30% and 29.42%, compared to Legacy-PSM and Adaptive-PSM schemes. Furthermore, Legacy-PSM was the only algorithm to introduce non-negligible packet loss rate.

In short, the results concerning the OPAMA implementation in Android depicted the proposal's capabilities to improve continuous media application energy efficiency / quality trade-off, which is not well supported by Legacy-PSM and Adaptive-PSM strategies.

6. OPAMA in Android devices

*— If I have seen further it is by
standing on the shoulders of gi-
ants.*

Isaac Newton

7

Conclusion and Future Work

MULTIMEDIA communication in IEEE 802.11 networks has been studied in the literature targeting distinct goals. Nevertheless, its energy efficiency is still an important topic to be addressed, heading towards a green wireless communication paradigm. This thesis contributed to advancing the state-of-the-art in this subject, proposing new energy-aware algorithms and real measurement facilities. This chapter provides a brief summary of this thesis in Section 7.1, and revisits its main contributions in Section 7.2. Finally, Section 7.3 outlines future research work.

7.1 Thesis Summary

Energy efficient communication in IEEE 802.11 networks has been addressed in distinct ways, including lower-layer optimization, cross-layer approaches, application design improvements or even user-driven solutions. Indeed, recently, the importance of end-users' perceived quality in the optimization process has started to play a crucial role in the acceptance of new multimedia applications, namely video streaming. The most relevant approaches presented in the literature, together with the introduction of basic concepts regarding this subject, were analyzed in Chapter 2. This literature

7. Conclusion and Future Work

review led to the main contributions proposed in this work.

The need for an integrated methodology that is able to measure, in a combined way, video energy consumption and quality, motivated the proposal of the EViTEQ framework, described in Chapter 3. The developed framework ensures a fully controlled testbed environment, encompassing the possibility of having repeatable tests with an easy configuration. Moreover, it employs high-precision energy measurement equipment, while being agnostic to the wireless technology. Besides the well-known QoS metrics, EViTEQ includes a thorough report of several state-of-the-art QoE metrics. Such contributions meet objective O.1 of this thesis.

To improve the power-saving mechanisms available in IEEE 802.11, so as to support continuous media application requirements, while considering the end-users' feedback (stated in thesis goal O.2), the Optimized Power save Algorithm for continuous Media Applications (OPAMA) has been proposed in Chapter 4. OPAMA has been assessed using the OMNeT++ simulator, with the end-user's perceived quality, Quality of Experience, being evaluated using a hybrid methodology, including both real and simulation-based environments. Additional tests with OPAMA in multi-station environments, against the standard IEEE 802.11 power-saving mechanism, revealed opportunities to enhance the proposed algorithm. This systematical analysis, as well as a new algorithm, OPAMA-EPS4ME, which was designed bearing in mind new issues raised by OPAMA performance with multiple stations, are presented in Chapter 5, which meets thesis goals O.2 and O.3.

Aiming at validating and studying the OPAMA approach in a state-of-the-art wireless access scenario, the EViTEQ framework was enhanced to allow the energy consumed to be measured in Android mobile devices, as presented in Chapter 6. When compared to IEEE 802.11 standard power-saving approaches and to an Android-specific power-saving strategy, OPAMA's simplified implementation showed the capability of user-driven approaches to achieve a good trade-off between energy consumption and application quality in the presence of continuous media applications.

7.2 Revisiting the Contributions

This section briefly revisits the main contributions of this thesis, which have already been presented in the introductory chapter, and highlights the main results achieved.

The proposed **EViTEQ framework** introduces a new assessment methodology, allowing video energy consumption and quality to be evaluated within distinct wireless access technologies and conditions. An **empirical assessment of video quality and**

energy consumption has been performed with the EViTEQ framework, addressing a gap in the literature regarding the integrated assessment of video energy consumption and quality in real testbeds. The conducted evaluation shows a clear relationship between video quality and its energy consumption, although the quality perceived by the end-users is highly dependent on the network conditions. This extensive assessment, with different videos and network conditions, highlighted the need for the EViTEQ framework to support the development of newly optimized energy-aware mechanisms, which aim at considering both video energy consumption and quality in an integrated way. Further evaluation performed to investigate energy consumption in IEEE 802.11 network interfaces showed EViTEQ's versatility to be applied in different use-cases and scenarios, and reported that considerable energy savings can be attained with an accurate management of wireless states.

The **proposal of a power saving algorithm for continuous media applications** stands out as the core contribution of this thesis. The Optimized Power save Algorithm for continuous Media Applications (OPAMA) was designed to improve IEEE 802.11 energy efficiency, taking into consideration the end-users' requirements. As a user-driven approach, OPAMA shows capabilities to enhance energy efficiency in various scenarios, while guaranteeing the users' expected QoE. Simulations performed in OMNeT++ showed that, compared to IEEE 802.11 Legacy-PSM, OPAMA can achieve energy savings of up to 63% in a high tolerance-to-delay scenario, and 44% for end-users allowing a maximum delay of 200 ms.

A detailed **performance assessment of IEEE 802.11 power saving mechanisms** in the OMNeT++ simulator has also been performed in this thesis. Aiming at studying the relationship between energy consumption and quality in the presence of multiple stations, several tests using both synthetic and video Variable Bit Rate traffic sources have been executed. The attained results depicted OPAMA's better performance to support multiple station environments, compared to IEEE 802.11's standard power saving mechanisms. Nonetheless, although with the best performance, OPAMA's energy-efficiency revealed to be directly affected by the number of stations in the network. Following the need to improve OPAMA under these access conditions, an **Enhanced Power Saving Mechanism for Multiple station Environment** (OPAMA-EPS4ME) has been proposed. OPAMA-EPS4ME's conceptual definition and modeling in OMNeT++ allowed for further assessment against other power saving algorithms, and showed OPAMA-EPS4ME's potential to overcome the main limitations identified in OPAMA, achieving higher energy savings in multiple station environments.

The **conceptual definition, design and implementation of an energy-aware An-**

7. Conclusion and Future Work

droid prototype was the final contribution of this thesis. Motivated by the several limitations identified concerning IEEE 802.11 management at the application level in Android, an Android framework for Extending Power Saving control to End-users (EXPoSE) has been advanced. Based on EXPoSE, a simplified version of OPAMA, Simplified-OPAMA, has been implemented in Android and evaluated against the available power saving algorithms. The obtained results with Simplified-OPAMA depicted the feasibility of OPAMA's concept to be implemented in state-of-the-art devices, leading to considerable energy saving compared to IEEE 802.11 Legacy-PSM and Android-specific Adaptive-PSM power saving schemes.

7.3 Future Work

Lead by the need to accomplish a sustainable computing paradigm where the resources must be managed within an energy-aware perspective, the subject of energy-efficient multimedia transmission in IEEE 802.11 wireless networks still involves efforts in the community. The methodologies and algorithms proposed in this thesis have shown some stimulating results concerning the employment of user-driven techniques to optimize the desired energy/quality ratio, but there are still open issues to be addressed in further studies.

Although many users mainly stream a single video session, the first point that needs to be addressed in the future is the impact of the proposed algorithms when used together with other applications with completely distinct requirements.

A second aspect to be addressed in further contributions is the end-user feedback. Instead of setting simple preferences at the application level, a self-learning scheme that is able to extract preferences from the end-users' actions and/or social behaviors should be investigated.

A third aspect to be considered pertains to the possible enhancements in scenarios where multiple stations are simultaneously accessing the network. Both OPAMA and OPAMA-EPS4ME are static solutions, which are only adapted based on the end-users' preferences, but do not take into consideration the application's service time. By considering the application's requirements and patterns, a highly dynamic and energy-efficient scheduling solution might be advanced.

References

- [A. P. Stephens et al., 2004] A. P. Stephens et al. IEEE p802.11 wireless lans: Usage models. technical report, IEEE 802.11n working document 802.11-03/802r23. May 2004. 80
- [Abdel Khalek and Dawy, 2011] A. Abdel Khalek and Z. Dawy. Energy-efficient cooperative video distribution with statistical qos provisions over wireless networks. *Mobile Computing, IEEE Transactions on*, PP(99):1, 2011. ISSN 1536-1233. doi: 10.1109/TMC.2011.127. 30, 31
- [Adams and Muntean, 2007] J. Adams and G-M. Muntean. Adaptive-buffer power save mechanism for mobile multimedia streaming. In *IEEE International Conference on Communications, 2007. ICC '07*, pages 4548 –4553, June 2007. doi: 10.1109/ICC.2007.751. 33, 35, 73
- [Alliance, 2015] Wi-Fi Alliance. Wi-fi alliance website. <http://www.wi-fi.org>, 2015. Last Visit: 01 February 2015. 8
- [Almes et al., 1999a] G. Almes, S. Kalidindi, and M. Zekauskas. A one-way delay metric for IPPM. RFC 2679, Internet Engineering Task Force, September 1999a. URL <http://www.rfc-editor.org/rfc/rfc2679.txt>. 17
- [Almes et al., 1999b] G. Almes, S. Kalidindi, and M. Zekauskas. A one-way packet loss metric for IPPM. RFC 2680, Internet Engineering Task Force, September 1999b. URL <http://www.rfc-editor.org/rfc/rfc2680.txt>. 17
- [Almes et al., 1999c] G. Almes, S. Kalidindi, and M. Zekauskas. A round-trip delay metric for IPPM. RFC 2681, Internet Engineering Task Force, September

REFERENCES

- 1999c. URL <http://www.rfc-editor.org/rfc/rfc2681.txt>. 17
- [Amuhong, 2015] Amuhong. IEEE 802.11 architecture in Android. <http://blog.chinaunix.net/uid-22415790-id-3651042.html>, 2015. Last visit: 03 February 2015. xxiii, 131
- [Android Open Source Project, 2015] Android Open Source Project. Android open-source software stack. <http://source.android.com/>, 2015. Last visit: 01 February 2015. 129
- [Apostolopoulos et al., 2002] J Apostolopoulos, W. Tan, and S. Wee. Video streaming: Concepts, algorithms, and systems. Technical Report 2002-260, HP Laboratories, Sep. 2002. URL <http://www.hpl.hp.com/techreports/2002/HPL-2002-260.pdf>. 18
- [Arno and Wheeler, 1993] S. Arno and F.S. Wheeler. Signed digit representations of minimal hamming weight. *Computers, IEEE Transactions on*, 42(8):1007–1010, Aug 1993. ISSN 0018-9340. doi: 10.1109/12.238495. 121
- [Balasubramanian et al., 2009] Niranjana Balasubramanian, Aruna Balasubramanian, and Arun Venkataramani. Energy consumption in mobile phones: a measurement study and implications for network applications. In *Proceedings of the 9th ACM SIGCOMM conference on Internet measurement conference, IMC '09*, pages 280–293, New York, NY, USA, 2009. ACM. ISBN 978-1-60558-771-4. doi: <http://doi.acm.org/10.1145/1644893.1644927>. URL <http://doi.acm.org/10.1145/1644893.1644927>. 28, 31
- [Bernardo et al., 2009] Vitor Bernardo, Kostas Pentikousis, Jarno Pinola, Esa Piri, and Marilia Curado. Multi-client video streaming over wirelessman-ofdma. In *Proceedings of the 4th ACM workshop on Performance monitoring and measurement of heterogeneous wireless and wired networks, PM2HW2N '09*, pages 46–53, New York, NY, USA, 2009. ACM. ISBN 978-1-60558-621-2. doi: <http://doi.acm.org/10.1145/1641913.1641920>. URL <http://doi.acm.org/10.1145/1641913.1641920>. 30, 31
- [Blender Foundation / Netherlands Media Art Institute, 2015] Blender Foundation / Netherlands Media Art Institute. Elephants Dream movie.

- <http://www.elephantsdream.org>, 2015. Last visit: 05 January 2015. 81, 112
- [Botta et al., 2012] Alessio Botta, Alberto Dainotti, and Antonio Pescapè. A tool for the generation of realistic network workload for emerging networking scenarios. *Computer Networks*, 56(15), 2012. 132
- [Broadcom, 2015] Broadcom. Broadcom bcm4329. <http://www.broadcom.com/products/Bluetooth/Bluetooth-RF-Silicon-and-Software-Solutions/BCM4329>, 2015. Last visit: 01 February 2015. 145
- [Camps-Mur et al., 2012] Daniel Camps-Mur, Manil Dev Gomony, Xavier Pérez-Costa, and Sebastià Sallent-Ribes. Leveraging 802.11n frame aggregation to enhance qos and power consumption in wi-fi networks. *Comput. Netw.*, 56(12):2896–2911, August 2012. ISSN 1389-1286. doi: 10.1016/j.comnet.2012.05.004. URL <http://dx.doi.org/10.1016/j.comnet.2012.05.004>. 32, 35, 80
- [Carbone and Rizzo, 2010] Marta Carbone and Luigi Rizzo. Dummynet revisited. *SIGCOMM Comput. Commun. Rev.*, 40:12–20, April 2010. ISSN 0146-4833. doi: <http://doi.acm.org/10.1145/1764873.1764876>. URL <http://doi.acm.org/10.1145/1764873.1764876>. 42
- [Cerrato, 2015] Ivan Cerrato. Kowalski kernel. <http://d-h.st/users/pengus77>, 2015. Last Visit: 06 January 2015. 130
- [CISCO, 2011] CISCO. 802.11n: The next generation of wireless performance. White paper, CISCO, 2011. 16
- [Correl, 2015] Kendal Correl. Ptp daemon (ptpd). 2015. Last visit: 15 January 2015. 46
- [Correll and Barendt, 2006] Kendall Correll and Nick Barendt. Design considerations for software only implementations of the ieee 1588 precision time protocol. In *In Conference on IEEE 1588 Standard for a Precision Clock Synchronization Protocol for Networked Measurement and Control Systems*, 2006. 47
- [Cui et al., 2013] Yong Cui, Xiao Ma, Hongyi Wang, Ivan Stojmenovic, and Jiangchuan Liu. A survey of energy efficient wireless transmission and

REFERENCES

- modeling in mobile cloud computing. *Mobile Networks and Applications*, 18(1):148–155, 2013. ISSN 1383-469X. doi: 10.1007/s11036-012-0370-6. URL <http://dx.doi.org/10.1007/s11036-012-0370-6>. 130
- [De Moor et al., 2010] Katrien De Moor, Istvan Ketyko, Wout Joseph, Tom Deryckere, Lieven De Marez, Luc Martens, and Gino Verleye. Proposed framework for evaluating quality of experience in a mobile, testbed-oriented living lab setting. *Mobile Networks and Applications*, 15:378–391, 2010. ISSN 1383-469X. URL <http://dx.doi.org/10.1007/s11036-010-0223-0>. 10.1007/s11036-010-0223-0. 30, 31
- [Demichelis and Chimento, 2002] C. Demichelis and P. Chimento. IP packet delay variation metric for IP performance metrics (IPPM). RFC 3393, Internet Engineering Task Force, November 2002. URL <http://www.rfc-editor.org/rfc/rfc3393.txt>. 17
- [Deng et al., 2011] Chenwei Deng, Weisi Lin, Bu sung Lee, Chiew Tong Lau, and Ming-Ting Sun. Performance analysis, parameter selection and extensions to h.264/avc for high resolution video coding. *Journal of Visual Communication and Image Representation*, 22(8):749 – 759, 2011. ISSN 1047-3203. doi: 10.1016/j.jvcir.2011.01.004. URL <http://www.sciencedirect.com/science/article/pii/S1047320311000198>. Emerging Techniques for High Performance Video Coding. 45
- [Ding et al., 2012] Ning Ding, A. Pathak, D. Koutsonikolas, C. Shepard, Y.C. Hu, and Lin Zhong. Realizing the full potential of psm using proxying. In *INFOCOM, 2012 Proceedings IEEE*, pages 2821–2825, 2012. doi: 10.1109/INFOCOM.2012.6195708. 32, 35
- [Dogar et al., 2010] Fahad R. Dogar, Peter Steenkiste, and Konstantina Papagianaki. Catnap: exploiting high bandwidth wireless interfaces to save energy for mobile devices. In *Proceedings of the 8th international conference on Mobile systems, applications, and services, MobiSys '10*, pages 107–122, New York, NY, USA, 2010. ACM. ISBN 978-1-60558-985-5. doi: 10.1145/1814433.1814446. URL <http://doi.acm.org/10.1145/1814433.1814446>. 35
- [EARTH, 2012] EARTH. Most Suitable Efficiency Metrics And Utility Functions.

-
- INFSO-ICT-247733 EARTH - Delivery D2.4 (Editors: Jose Alonso-Rubio, Pter Fazekas, Per Skillermark, Wieslawa Wajda)*, pages 1–55, 2012. 66
- [H323forum, 2015] H323forum. H.323 products and services. <http://www.h323forum.org/>, 2015. Last Visit: 04 February 2015. 17
- [Hall et al., 2012] Tomas Hall, Per Hurtig, and Johan Garcia and Anna Brunstrom. Performance evaluation of kaunet in physical and virtual emulation environments. Technical Report Technical Report No 2012:32., Karlstad University, Feb. 2012. 42
- [Han et al., 2012] Hao Han, Yunxin Liu, Guobin Shen, Yongguang Zhang, and Qun Li. DozyAP: Power-efficient wi-fi tethering. In *Proceedings of the 10th International Conference on Mobile Systems, Applications, and Services, MobiSys '12*, page 421434, New York, NY, USA, 2012. ACM. ISBN 978-1-4503-1301-8. URL <http://doi.acm.org/10.1145/2307636.2307675>. 146
- [Hih Heng Ke et al., 2008] hih Heng Ke, Ce-Kuen Shieh, Wen-Shyang Hwang, and Artur Ziviani. An evaluation framework for more realistic simulations of MPEG video transmission. *Journal of Information Science and Engineering*, 24(2):425–440, 2008. 78
- [Hoque et al., 2013] M.A. Hoque, M. Siekkinen, J.K. Nurminen, and M. Aalto. Dissecting mobile video services: An energy consumption perspective. In *World of Wireless, Mobile and Multimedia Networks (WoWMoM), 2013 IEEE 14th International Symposium and Workshops on a*, pages 1–11, June 2013. doi: 10.1109/WoWMoM.2013.6583384. 30, 31
- [Hostapd, 2015] Hostapd. hostapd: ieee 802.11 ap, ieee 802.1x/wpa/wpa2/eap/radius authenticator. <http://hostap.epitest.fi/hostapd/>, 2015. Last visit: 12 January 2015. 144
- [Huynh-Thu and Ghanbari, 2008] Q. Huynh-Thu and M. Ghanbari. Scope of validity of psnr in image/video quality assessment. *Electronics Letters*, 44(13):800–801, 2008. ISSN 0013-5194. doi: 10.1049/el:20080522. 79

REFERENCES

- [IEEE, 2004] IEEE. Standard digital interface for programmable instrumentation - part 2: Codes, formats, protocols and common commands (adoption of (ieee std 488.2-1992). *IEC 60488-2 First edition 2004-05; IEEE 488.2*, pages 1–261, 2004. doi: 10.1109/IEEESTD.2004.95390. 41
- [IEEE, 2005] IEEE. IEEE std 802.11e-2005 (amendment to ieeee std 802.11-1999. pages 0–189, 2005. doi: 10.1109/IEEESTD.2005.97890. 8, 13
- [IEEE, 2007] IEEE. IEEE standard for information technology - telecommunications and information exchange between systems - local and metropolitan area networks - specific requirements - part 11: Wireless LAN medium access control (MAC) and physical layer (PHY) specifications. *IEEE Std 802.11-2007 (Revision of IEEE Std 802.11-1999)*, pages 1–1076, 2007. doi: 10.1109/IEEESTD.2007.373646. 8
- [IEEE, 2009] IEEE. IEEE std 802.11n-2009 (amendment to ieeee std 802.11-2007). pages 1 –565, 2009. doi: 10.1109/IEEESTD.2009.5307322. 8, 13
- [IEEE, 2012] IEEE. IEEE standard for information technology Telecommunications and information exchange between systems local and metropolitan area networks Specific requirements part 11: Wireless LAN medium access control (MAC) and physical layer (PHY) specifications. *IEEE Std 802.11-2012 (Revision of IEEE Std 802.11-2007)*, pages 1–2793, 2012. doi: 10.1109/IEEESTD.2012.6178212. 2, 8, 11, 13
- [IEEE, 2013] IEEE. Ieee standard for information technology– telecommunications and information exchange between systems local and metropolitan area networks– specific requirements–part 11: Wireless lan medium access control (mac) and physical layer (phy) specifications–amendment 4: Enhancements for very high throughput for operation in bands below 6 ghz. *IEEE Std 802.11ac-2013 (Amendment to IEEE Std 802.11-2012, as amended by IEEE Std 802.11ae-2012, IEEE Std 802.11aa-2012, and IEEE Std 802.11ad-2012)*, pages 1–425, Dec 2013. doi: 10.1109/IEEESTD.2013.6687187. 9, 10
- [IETF, 2015] IETF. IP Performance Metrics (ippm) working group. <http://www.ietf.org/html.charters/ippm-charter.html>, 2015. Last visit: 10 January 2015. 17

- [ITU-T, 1996] ITU-T. ITU-T Recommendation P.800 - Methods for subjective determination of transmission quality. Technical report, International Telecommunication Union, August 1996. 21
- [ITU-T, 2000a] ITU-T. ITU-T recommendation F.700 - framework recommendation for multimedia services. Technical report, International Telecommunication Union, 2000a. 20
- [ITU-T, 2000b] ITU-T. ITU-T Recommendation J.143 - User Requirements for Objective Perceptual Video Quality Measurements in Digital Cable Television. Technical report, International Telecommunication Union, May 2000b. 24
- [ITU-T, 2008] ITU-T. Objective perceptual multimedia video quality measurement in the presence of a full reference. Recommendation J.247, International Telecommunication Union, Geneva, August 2008. 25, 80
- [ITU-T, 2010] ITU-T. ITU-T recommendation H.264 : Advanced video coding for generic audiovisual services. Technical report, International Telecommunication Union, Mar 2010. 17, 18
- [ITU-T, 2013] ITU-T. H.323 : Packet-based multimedia communications systems - itu-t h.323 v7 (2009) amd. 1 (03/2013). Technical report, International Telecommunication Union, 2013. URL <http://www.itu.int/ITU-T/recommendations/rec.aspx?rec=11865&lang=en>. 17
- [Keimel et al., 2012] Christian Keimel, Arne Redl, and Klaus Diepold. The tum high definition video datasets. In *Forth International Workshop on Quality of Multimedia Experience (QoMEX 2012)*, Jul 2012. 44
- [Kennedy et al., 2012] M. Kennedy, A. Ksentini, Y. Hadjadj-Aoul, and G.-M. Muntean. Adaptive energy optimization in multimedia-centric wireless devices: A survey. *Communications Surveys Tutorials, IEEE*, PP(99): 1–19, 2012. ISSN 1553-877X. doi: 10.1109/SURV.2012.072412.00115. 35
- [Klaue et al., 2003] Jirka Klaue, Berthold Rathke, and Adam Wolisz. EvalVid - A Framework for Video Transmission and Quality Evaluation. In *Proceedings of the 13th Conference on Modelling Techniques and Tools for Computer Performance Evaluation, Lecture Notes in Computer Science*, pages 255–272. Springer, 2003. doi: 10.1007/b12028.

REFERENCES

- URL <http://www.tkn.tu-berlin.de/publications/papers/evalvid.pdf> AND <http://citeseer.ist.psu.edu/klaue03evalvid.html>. 40, 78
- [Lee and Knight, 2005] Chae-Sub Lee and D. Knight. Realization of the next-generation network. *Communications Magazine, IEEE*, 43(10):34–41, 2005. ISSN 0163-6804. doi: 10.1109/MCOM.2005.1522122. 1
- [Lee et al., 2010] Sunghee Lee, Jahon Koo, and Kwangsue Chung. Content-aware rate control scheme to improve the energy efficiency for mobile iptv. In *Consumer Electronics (ICCE), 2010 Digest of Technical Papers International Conference on*, pages 445–446, jan. 2010. doi: 10.1109/ICCE.2010.5418958. 30, 31
- [Li et al., 2011] G.Y. Li, Zhikun Xu, Cong Xiong, Chenyang Yang, Shunqing Zhang, Yan Chen, and Shugong Xu. Energy-efficient wireless communications: tutorial, survey, and open issues. *Wireless Communications, IEEE*, 18(6): 28–35, 2011. ISSN 1536-1284. doi: 10.1109/MWC.2011.6108331. 61
- [Li et al., 2009] Ye Li, M. Reisslein, and C. Chakrabarti. Energy-efficient video transmission over a wireless link. *Vehicular Technology, IEEE Transactions on*, 58(3):1229–1244, march 2009. ISSN 0018-9545. doi: 10.1109/TVT.2008.927720. 30, 31
- [Lin and Wong, 2006] Yuxia Lin and V.W.S. Wong. Wsn01-1: Frame aggregation and optimal frame size adaptation for ieee 802.11n wlans. In *Global Telecommunications Conference, 2006. GLOBECOM '06. IEEE*, pages 1–6, Nov 2006. doi: 10.1109/GLOCOM.2006.925. 34, 35
- [Lo et al., 2005] Anthony Lo, Geert Heijenk, and Ignas Niemegeers. Evaluation of mpeg-4 video streaming over umts/wcdma dedicated channels. In *Proceedings of the First International Conference on Wireless Internet, WICON '05*, pages 182–189, Washington, DC, USA, 2005. IEEE Computer Society. ISBN 0-7695-2382-X. doi: 10.1109/WICON.2005.15. URL <http://dx.doi.org/10.1109/WICON.2005.15>. 78
- [Lorchat and Noel, 2005] J. Lorchat and T. Noel. Reducing power consumption in ieee 802.11 networks. In *Wireless And Mobile Computing, Networking And Communications, 2005. (WiMob'2005), IEEE International Conference*

- on, pages 106 – 110 Vol. 2, August 2005. doi: 10.1109/WIMOB.2005.1512858. 34, 35
- [MSU Graphics & Media Lab (Video Group), 2015] MSU Graphics & Media Lab (Video Group). MSU Video Quality Measurement Tool. 2015. Last visit: 15 January 2015. 43
- [Naik, 2010] Kshirasagar Naik. A survey of software based energy saving methodologies for handheld wireless communication devices. *Tech. Report No. 2010-13, Dept. of ECE, University of Waterloo*, 2010. 35
- [Noma et al., 2015] AdamuM. Noma, Mohamed Othman, KwehY. Lun, and Idawaty Ahmad. Two-level frames aggregation with enhanced a-msdu for ieee 802.11n wlans. *Wireless Personal Communications*, pages 1–14, 2015. ISSN 0929-6212. doi: 10.1007/s11277-015-2301-x. URL <http://dx.doi.org/10.1007/s11277-015-2301-x>. 9
- [Orosz et al., 2014] P. Orosz, T. Skopko, Z. Nagy, P. Varga, and L. Gyimothi. A case study on correlating video qos and qoe. In *Network Operations and Management Symposium (NOMS), 2014 IEEE*, pages 1–5, May 2014. doi: 10.1109/NOMS.2014.6838399. 2
- [Ostermann et al., 2004] J. Ostermann, J. Bormans, P. List, D. Marpe, M. Narroschke, F. Pereira, T. Stockhammer, and T. Wedi. Video coding with h.264/avc: tools, performance, and complexity. *Circuits and Systems Magazine, IEEE*, 4(1):7 – 28, 2004. ISSN 1531-636X. doi: 10.1109/MCAS.2004.1286980. 18
- [Palit et al., 2011] R. Palit, K. Naik, and A. Singh. Impact of packet aggregation on energy consumption in smartphones. In *Wireless Communications and Mobile Computing Conference (IWCMC), 2011 7th International*, pages 589–594, July 2011. doi: 10.1109/IWCMC.2011.5982599. 33, 35
- [Pathak et al., 2012] Abhinav Pathak, Y. Charlie Hu, and Ming Zhang. Where is the energy spent inside my app?: fine grained energy accounting on smartphones with eprof. In *Proceedings of the 7th ACM european conference on Computer Systems, EuroSys '12*, pages 29–42, New York, NY, USA, 2012. ACM. ISBN 978-1-4503-1223-3. doi: 10.1145/2168836.2168841. URL <http://doi.acm.org/10.1145/2168836.2168841>. 35

REFERENCES

- [PEVQ, 2015] PEVQ. PEVQ Perceptual Evaluation of Video Quality. <http://www.pevq.org>, 2015. Last visit: 15 January 2015. 25, 26
- [Picard and Lafond, 2014] V. Picard and E. Lafond. Performance evaluation of next generation wi-fi (802.11ac) for mobile offloading. In *Consumer Communications and Networking Conference (CCNC), 2014 IEEE 11th*, pages 515–516, Jan 2014. doi: 10.1109/CCNC.2014.6994391. 3
- [Pinson and Wolf, 2004] M.H. Pinson and S. Wolf. A new standardized method for objectively measuring video quality. *Broadcasting, IEEE Transactions on*, 50(3):312 – 322, sept. 2004. ISSN 0018-9316. doi: 10.1109/TBC.2004.834028. 24, 25
- [Prez-Costa et al., 2007] Xavier Prez-Costa, Daniel Camps-Mur, and Albert Vidal. On distributed power saving mechanisms of wireless lans 802.11e u-apsd vs 802.11 power save mode. *Computer Networks*, 51(9):2326 – 2344, 2007. ISSN 1389-1286. doi: <http://dx.doi.org/10.1016/j.comnet.2007.01.026>. 15
- [Rice and Hay, 2010] Andrew Rice and Simon Hay. Measuring mobile phone energy consumption for 802.11 wireless networking. *Pervasive Mob. Comput.*, 6:593–606, December 2010. ISSN 1574-1192. doi: <http://dx.doi.org/10.1016/j.pmcj.2010.07.005>. URL <http://dx.doi.org/10.1016/j.pmcj.2010.07.005>. 29, 31, 41, 132
- [Rubino, 2005] G. Rubino. Quantifying the quality of audio and video transmissions over the internet: the psqa approach. Imperial College Press, UK, 2005. 26
- [Saif et al., 2012] Anwar Saif, Mohamed Othman, Shamala Subramaniam, and NorAsilaWatiAbdul Hamid. An enhanced a-msdu frame aggregation scheme for 802.11n wireless networks. *Wireless Personal Communications*, 66(4):683–706, 2012. ISSN 0929-6212. doi: 10.1007/s11277-011-0358-8. URL <http://dx.doi.org/10.1007/s11277-011-0358-8>. 34, 35
- [Sanaei et al., 2014] Z. Sanaei, S. Abolfazli, A. Gani, and R. Buyya. Heterogeneity in mobile cloud computing: Taxonomy and open challenges. *Communications Surveys Tutorials, IEEE*, 16(1):369–392, First 2014. ISSN 1553-877X. doi: 10.1109/SURV.2013.050113.00090. 2

- [Schlachter, 2013] Fred Schlachter. No moore's law for batteries. *Proceedings of the National Academy of Sciences*, 110(14):5273–5273, 2013. 2
- [Sesia et al., 2009] Stefania Sesia, Issam Toufik, and Matthew Baker, editors. *LTE - The UMTS Long Term Evolution: From Theory to Practice*. John Wiley and Sons, Ltd, 2009. 2
- [Shah et al., 2014] Zawar Shah, Ather Suleman, Imdad Ullah, and Adeel Baig. Effect of transmission opportunity and frame aggregation on voip capacity over ieee 802.11n w lans. In *Signal Processing and Communication Systems (ICSPCS), 2014 8th International Conference on*, pages 1–7, Dec 2014. doi: 10.1109/ICSPCS.2014.7021093. 67
- [Shen and Qiu, 2013] Hao Shen and Qinru Qiu. User-aware energy efficient streaming strategy for smartphone based video playback applications. In *Design, Automation Test in Europe Conference Exhibition (DATE), 2013*, pages 258–261, 2013. doi: 10.7873/DATE.2013.065. 33, 35
- [Shih et al., 2002] Eugene Shih, Paramvir Bahl, and Michael J. Sinclair. Wake on wireless: an event driven energy saving strategy for battery operated devices. In *Proceedings of the 8th annual international conference on Mobile computing and networking, MobiCom '02*, pages 160–171, New York, NY, USA, 2002. ACM. ISBN 1-58113-486-X. doi: <http://doi.acm.org/10.1145/570645.570666>. URL <http://doi.acm.org/10.1145/570645.570666>. 29, 31
- [Skordoulis et al., 2008] D. Skordoulis, Qiang Ni, Hsiao-Hwa Chen, A.P. Stephens, Changwen Liu, and A. Jamalipour. Ieee 802.11n mac frame aggregation mechanisms for next-generation high-throughput w lans. *Wireless Communications, IEEE*, 15(1):40–47, February 2008. ISSN 1536-1284. doi: 10.1109/MWC.2008.4454703. 9
- [Statista, 2015] Statista. Global wi-fi enabled equipment shipments from 2012 to 2017 (in billion units). <http://www.statista.com/statistics/282512/global-wi-fi-enabled-equipment-shipments>, 2015. Last Visit: 15 February 2015. 8
- [Tan et al., 2007] Enhua Tan, Lei Guo, Songqing Chen, and Xiaodong Zhang. Psm-throttling: Minimizing energy consumption for bulk data communications in w lans. In *Network Protocols, 2007. ICNP 2007. IEEE International*

REFERENCES

- Conference on*, pages 123 –132, October 2007. doi: 10.1109/ICNP.2007.4375843. 32, 35
- [tcpdump, 2015] tcpdump. tcpdump, a powerful command-line packet analyzer; and libpcap, a portable C/C++ library for network traffic capture. <http://www.tcpdump.org/>, 2015. Last visit: 07 January 2015. 40
- [Tomar, 2006] Suramya Tomar. Converting video formats with ffmpeg. *Linux J.*, 2006:10–, June 2006. ISSN 1075-3583. URL <http://dl.acm.org/citation.cfm?id=1134782.1134792>. 45, 81
- [Tozlu et al., 2012] S. Tozlu, M. Senel, Wei Mao, and A. Keshavarzian. Wi-fi enabled sensors for internet of things: A practical approach. *Communications Magazine, IEEE*, 50(6):134 –143, June 2012. ISSN 0163-6804. doi: 10.1109/MCOM.2012.6211498. 69
- [Trestian et al., 2012] R. Trestian, A.-N. Moldovan, O. Ormond, and G. Muntean. Energy consumption analysis of video streaming to android mobile devices. In *Network Operations and Management Symposium (NOMS), 2012 IEEE*, pages 444–452, April 2012. doi: 10.1109/NOMS.2012.6211929. 29, 31
- [Tsao and Huang, 2011] Shiao-Li Tsao and Chung-Huei Huang. A survey of energy efficient {MAC} protocols for {IEEE} 802.11 {WLAN}. *Computer Communications*, 34(1):54 – 67, 2011. ISSN 0140-3664. doi: <http://dx.doi.org/10.1016/j.comcom.2010.09.008>. URL <http://www.sciencedirect.com/science/article/pii/S014036641000424X>. 12, 137
- [Ucar et al., 2012] I. Ucar, J. Navarro-Ortiz, P. Ameigeiras, and J.M. Lopez-Soler. Video tester - a multiple-metric framework for video quality assessment over ip networks. In *Broadband Multimedia Systems and Broadcasting (BMSB), 2012 IEEE International Symposium on*, pages 1–5, 2012. doi: 10.1109/BMSB.2012.6264243. 40
- [Van der Auwera et al., 2008] G. Van der Auwera, P.T. David, and M. Reisslein. Traffic and quality characterization of single-layer video streams encoded with the h.264/mpeg-4 advanced video coding standard and scalable

- video coding extension. *Broadcasting, IEEE Transactions on*, 54(3):698 – 718, September 2008. ISSN 0018-9316. doi: 10.1109/TBC.2008.2000422. 81, 112
- [Varga and Hornig, 2008] András Varga and Rudolf Hornig. An overview of the omnet++ simulation environment. In *Proceedings of the 1st international conference on Simulation tools and techniques for communications, networks and systems & workshops, Simutools '08*, pages 60:1–60:10, ICST, Brussels, Belgium, Belgium, 2008. ICST (Institute for Computer Sciences, Social-Informatics and Telecommunications Engineering). ISBN 978-963-9799-20-2. URL <http://dl.acm.org/citation.cfm?id=1416222.1416290>. 5, 80
- [Vergara and Nadjm-Tehrani, 2013] EkhiotzJon Vergara and Simin Nadjm-Tehrani. Energybox: A trace-driven tool for data transmission energy consumption studies. In Jean-Marc Pierson, Georges Da Costa, and Lars Dittmann, editors, *Energy Efficiency in Large Scale Distributed Systems*, Lecture Notes in Computer Science, pages 19–34. Springer Berlin Heidelberg, 2013. ISBN 978-3-642-40516-7. doi: 10.1007/978-3-642-40517-4.2. URL http://dx.doi.org/10.1007/978-3-642-40517-4_2. 29, 31
- [Verma et al., 2013] L. Verma, M. Fakharzadeh, and Sunghyun Choi. Wifi on steroids: 802.11ac and 802.11ad. *Wireless Communications, IEEE*, 20(6):30–35, December 2013. ISSN 1536-1284. doi: 10.1109/MWC.2013.6704471. 9, 10
- [VQEG, 2015] VQEG. Video Quality Experts Group - Final Report from the Video Quality Experts Group on the Validation of Objective Models of Video Quality Assessment, Phase II. <http://www.vqeg.org>, 2015. Last visit: 03 January 2015. 25
- [Wang and Manner, 2010] Le Wang and J. Manner. Energy consumption analysis of wlan, 2g and 3g interfaces. In *Green Computing and Communications (GreenCom), 2010 IEEE/ACM Int'l Conference on Int'l Conference on Cyber, Physical and Social Computing (CPSCom)*, pages 300–307, dec. 2010. doi: 10.1109/GreenCom-CPSCom.2010.81. 28, 31, 41

REFERENCES

- [Wang et al., 2015] Z. Wang, A.C. Bovik, H.R. Sheikh, and E.P. Simoncelli. The SSIM Index for Image Quality Assessment. <http://www.ece.uwaterloo.ca/~z70wang/research/ssim/>, 2015. Last visit: 05 January 2015. 24
- [Wang et al., 2004] Zhou Wang, A.C. Bovik, H.R. Sheikh, and E.P. Simoncelli. Image quality assessment: from error visibility to structural similarity. *Image Processing, IEEE Transactions on*, 13(4):600–612, April 2004. ISSN 1057-7149. doi: 10.1109/TIP.2003.819861. 23, 79
- [Wechsung and De Moor, 2014] Ina Wechsung and Katrien De Moor. Quality of experience versus user experience. In Sebastian Mller and Alexander Raake, editors, *Quality of Experience*, T-Labs Series in Telecommunication Services, pages 35–54. Springer International Publishing, 2014. ISBN 978-3-319-02680-0. doi: 10.1007/978-3-319-02681-7_3. URL http://dx.doi.org/10.1007/978-3-319-02681-7_3. 2
- [Wiegand et al., 2003] T. Wiegand, G.J. Sullivan, G. Bjontegaard, and A. Luthra. Overview of the h.264/avc video coding standard. *Circuits and Systems for Video Technology, IEEE Transactions on*, 13(7):560–576, jul. 2003. ISSN 1051-8215. doi: 10.1109/TCSVT.2003.815165. 18
- [Winkler, 2007] S. Winkler. Video quality and beyond. *15th European Signal Processing Conference*, September 2007. 24
- [Winkler and Mohandas, 2008] S. Winkler and P. Mohandas. The evolution of video quality measurement: From psnr to hybrid metrics. *Broadcasting, IEEE Transactions on*, 54(3):660–668, September 2008. ISSN 0018-9316. doi: 10.1109/TBC.2008.2000733. 22, 23, 30
- [Wu et al., 2014] Linlin Wu, S.K. Garg, S. Versteeg, and R. Buyya. Sla-based resource provisioning for hosted software-as-a-service applications in cloud computing environments. *Services Computing, IEEE Transactions on*, 7(3):465–485, July 2014. ISSN 1939-1374. doi: 10.1109/TSC.2013.49. 2
- [Y.1541, 2011] ITU-T Y.1541. Y.1541: Network Performance Objectives for IP-Based Services. Technical report, International Telecommunication Union, 2011. URL <http://www.itu.int/itudoc/itu-t/aap/sg13aap/history/y1541/y1541.html>. 148

- [Yuan et al., 2006] Wanghong Yuan, K. Nahrstedt, S.V. Adve, D.L. Jones, and R.H. Kravets. Grace-1: cross-layer adaptation for multimedia quality and battery energy. *Mobile Computing, IEEE Transactions on*, 5(7):799 – 815, july 2006. ISSN 1536-1233. doi: 10.1109/TMC.2006.98. 30, 31
- [Zhu et al., 2012] Yi-hua Zhu, Han-cheng Lu, and V.C.M. Leung. Access point buffer management for power saving in iee 802.11 wlans. *Network and Service Management, IEEE Transactions on*, 9(4):473 –486, December 2012. ISSN 1932-4537. doi: 10.1109/TNSM.2012.062512.110188. 72

REFERENCES
